





SPECIFICATION SHEET NO.	T0129 – DSK14W0000S040	
ORIGINAL MFG/PART NO.	 MDD Diodes/DSK14	
NEXTGEN PART CODE	DSK14W0000S040	Indicate This Code For RFQ /Order
DATE	Jan. 29, 2026	
REVISION	A6	Updated With Most Recent Data
DESCRIPTION AND MAIN PARAMETRICS	<p>SMD Schottky Barrier Rectifier 2 Pads, Case SOD-123FL, DSK1 Series, Average Forward Rectified Current 1.0A Max.</p> <p>RMS Voltage 28V Max.</p> <p>Repetitive Peak Reverse Voltage 40V Max.</p> <p>Operating Junction & Storage Temperature Range TJ,TSTG : -55°C ~+150°C</p> <p>Package in Tape/Reel, 3000pcs/Reel</p> <p>REACH/RoHS/RoHS III compliant, RoHS Annex III lead Exemption (Exempt per RoHS EU 2015/863) and Halogen Free (HF)</p>	
CUSTOMER		
CUSTOMER PART NUMBER		
CROSS REF. PART NUMBER		
MEMO		

VENDOR APPROVE		
Issued/Checked/Approved		
		
Effective Date: Jan. 29, 2026		

CUSTOMER APPROVE	
Date:	

MAIN FEATURE

- The Plastic Package Carries Underwriters Laboratory Flammability Classification 94V-0
- Low Power Loss and High Efficiency
- Metal Silicon Junction and Majority Carrier Conduction
- Built-in Strain Relief and Ideal For Automated Placement
- High Forward Surge Current Capability
- High Temperature Soldering Guaranteed: 250°C/10 Seconds At Terminals
- Surface Mount Package Ideally Suited for Automatic Insertion
- Cross Main Competitor Parts in Market
- REACH/RoHS/RoHS III compliant, RoHS Annex III lead Exemption (Exempt per RoHS EU 2015/863) and Halogen Free (HF)



Image shown is a representation only. Exact specifications should be obtained from the product dimension.



APPLICATION

- For SMD Application

ELECTRICAL CHARACTERISTICS

- See Page 5 ~ Page 6
- All Products Parameters are Subject To NextGen Components' Final Confirmation.

HOW TO ORDER

- Please Follow Up Part Code Guide And Indicate NextGen Part Code DSK14W0000S040 For RFQ and Order.

RFQ
Request For Quotation

PART CODE GUIDE

CODE	NAME	KEY SPECIFICATION OPTION
DSK1	Product Series Code	SMD Schottky Barrier Rectifier, Forward Current 1.0A
4	Repetitive Peak Reverse Voltage Code	2: 20V Max. ; 3: 30V Max. ; 4: 40V Max.; 5: 50V Max.; 6: 60V Max.; 8: 80V Max.; 10: 100V Max.; 15: 150V Max.; 20: 200V Max
W0	Case Code	A0: Case DO-214AC/SMA; B0: Case DO-214AA/SMB; BF: Case SMBF; C0: Case SMC/DO-214AB ; F0: Case SMAF; W0: Case SMF/SOD-123FL
000S	Internal Control Code	000S: Letter A~Z, a-z or Digits (0-9)
040	DC Blocking Voltage Code	020: 20V Max. ; 030: 30V Max. ; 040: 40V Max.; 050: 50V Max.; 060: 60V Max.; 080: 80V Max.; 100: 100V Max.; 150: 150V Max.; 200: 200V Max
XX	Special/Custom Parameters	Blank: N/A; XX: Letter A~Z, a~z or digits (0~9) for Special/Custom Parameters

DIMENSION - Unit: Inch (mm), SOD-123FL Outline

Top View

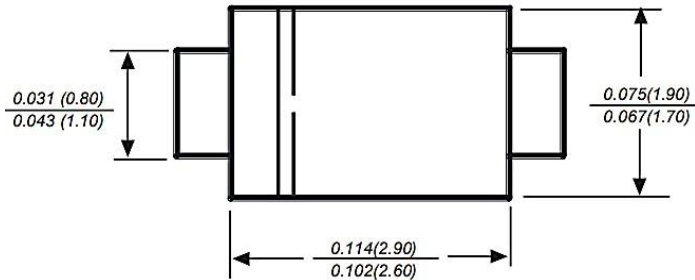

Side View

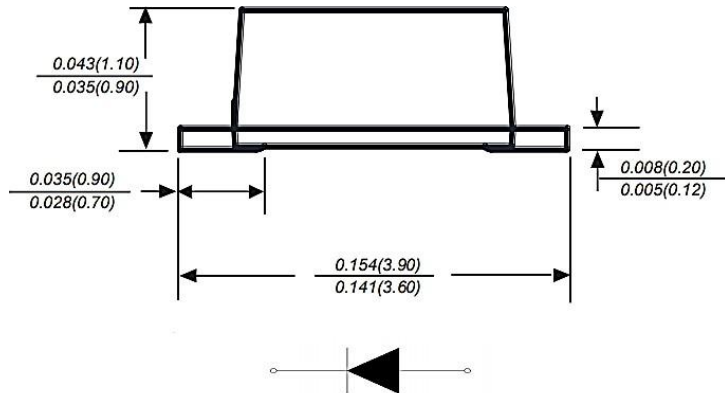

Recommend Pad Layout

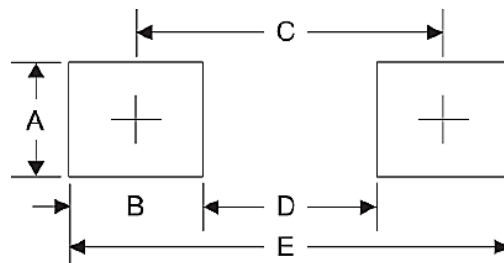

SYMBOL	A	B	C	D	E
Unit (inch)	0.047	0.047	0.126	0.079	0.173
Unit (mm)	1.2	1.2	3.1	2.0	4.4

MECHANICAL DATA

CASE	TERMINALS	POLARITY	MOUNTING POSITION	WEIGHT PER PIECE
JEDEC SOD-123FL Molded Plastic Body	Solder plated, Solderable per MIL-STD-750, Method 2026	Polarity Symbol Marking On Case	Any	0.0007 Ounce, 0.0200 Grams

MAX. RATINGS & ELECTRICAL CHARACTERISTICS

- Ratings at 25 °C ambient temperature unless otherwise specified.
- Single phase half-wave 60Hz, resistive or inductive load, for capacitive load current derate by 20%.

PARAMETER	SYMBOLS	VALUE	UNITS
Maximum Average Forward Rectified Current at TL (see fig.1)	I _{AV}	1.0	A
Peak Forward Surge Current 8.3ms Single Half Sine-wave Superimposed On Rated Load (JEDEC Method)	I _{FSM}	25	A
Typical Thermal Resistance	R _{θJA}	100	°C/W
Operating Junction e Temperature Range	T _J	-55 to +150	°C
Storage Temperature Range	T _{STG}	-55 to +150	°C

Note: Measured at 1MHz And Applied Reverse Voltage Of 4.0V D.C

MAX. RATINGS & ELECTRICAL CHARACTERISTICS - FOR DIFFERENT PART CODE

- Ratings At 25 °C Ambient Temperature Unless Otherwise Specified.
- Single Phase Half-wave 60Hz, resistive Or Inductive Load, For Capacitive Load Current Derate By 20%.

PART CODE	Max. Repetitive Peak Reverse Voltage	Max. RMS Vol.	Max. DC Blocking Voltage	Max. Inst. Forward Voltage @ 1.0A	Max. DC Reverse Current At Rated DC Blocking Voltage		Typical Junction Cap. (Note 1)	Marking List
					@	@		
					25 °C	100 °C		
					V_{RRM}	V_{RMS}		
V	V	V	V	mA	pF			
DSK12W0000S020	20	14	20	0.55	0.3	10	110	K12
DSK14W0000S040	40	28	40	0.55	0.3	10	110	K14
DSK15W0000S050	50	35	50	0.70	0.3	10	80	K15
DSK16W0000S060	60	42	60	0.70	0.3	10	80	K16
DSK18W0000S080	80	56	80	0.85	0.3	10	80	K18
DSK110W000S100	100	70	100	0.85	0.2	5.0	80	K110
DSK115W000S150	150	105	150	0.85	0.1	2.0	80	K115
DSK120W000S200	200	140	200	0.90	0.1	2.0	80	K120

Note: 1. Measured at 1MHz And Applied Reverse Voltage Of 4.0V D.C

RATINGS & CHARACTERISTIC CURVES - For Reference Only

Fig.1 Forward Current Derating Curve

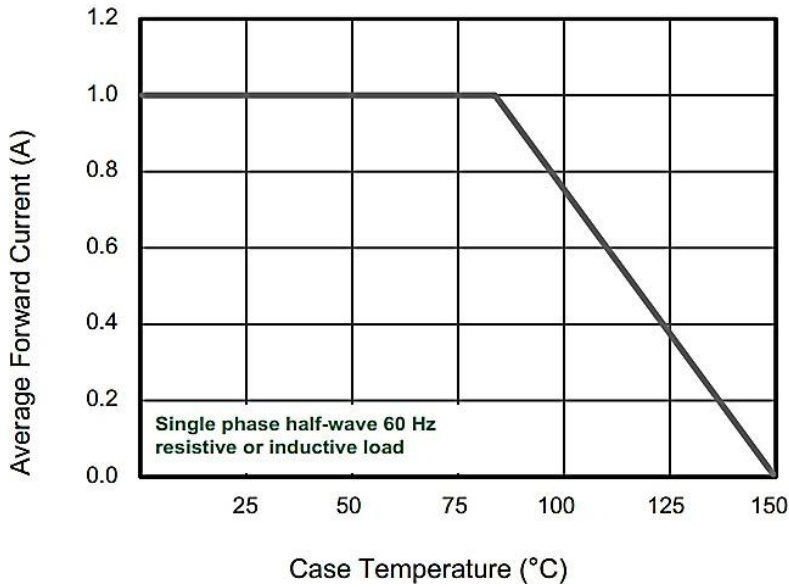
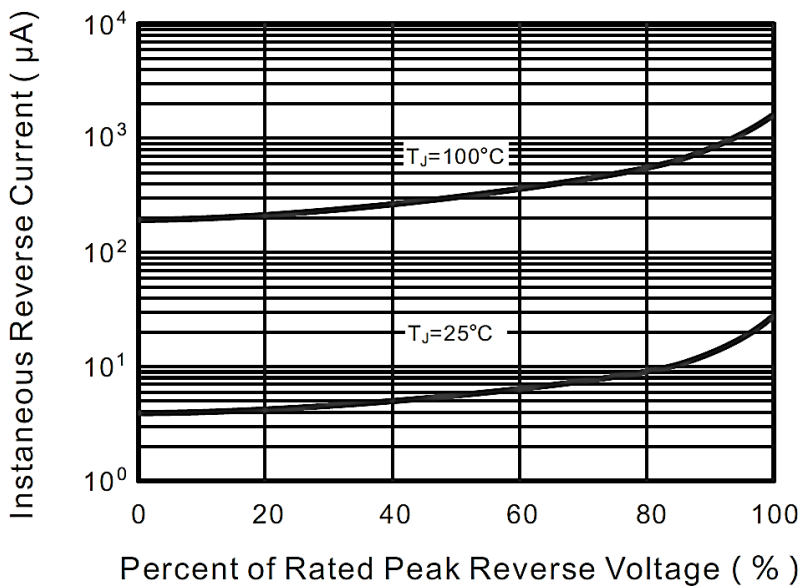

Fig.2 Typical Reverse Characteristics



RATINGS & CHARACTERISTIC CURVES - For Reference Only

Fig.3 Typical Forward Characteristic

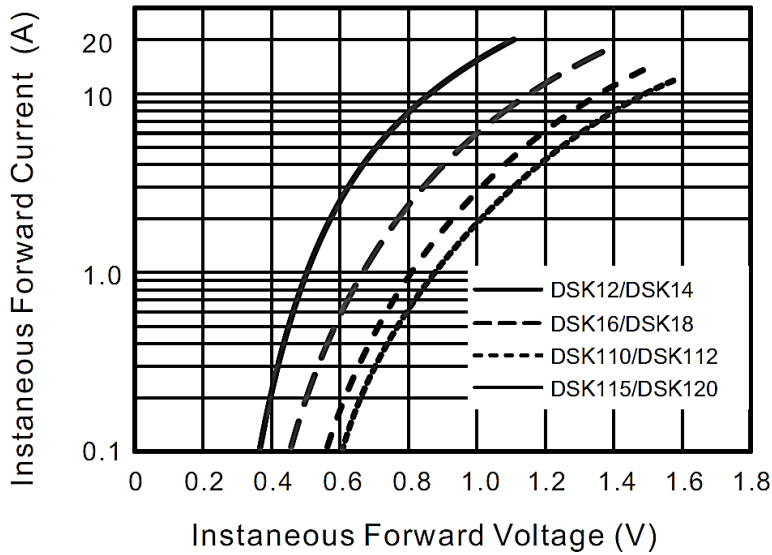
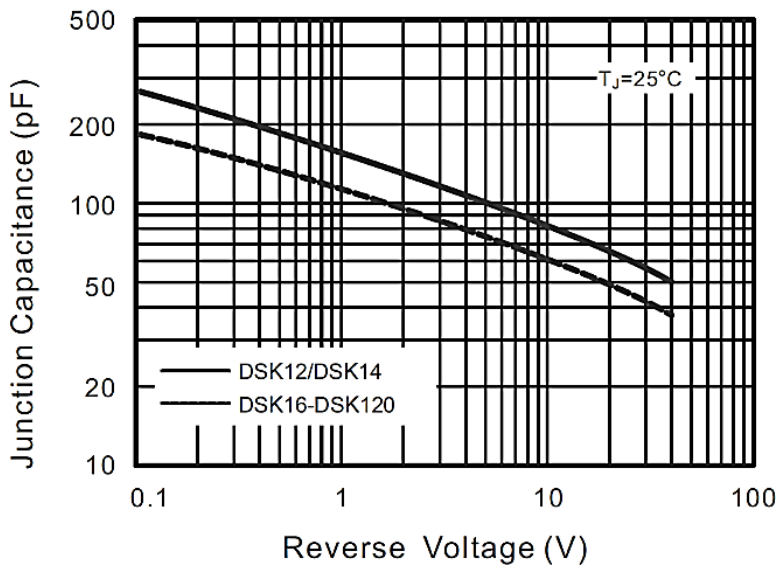

Fig.4 Typical Junction Capacitance



RATINGS & CHARACTERISTIC CURVES - For Reference Only

Fig.5 Maximum Non-Repetitive Peak Forward Surge Current

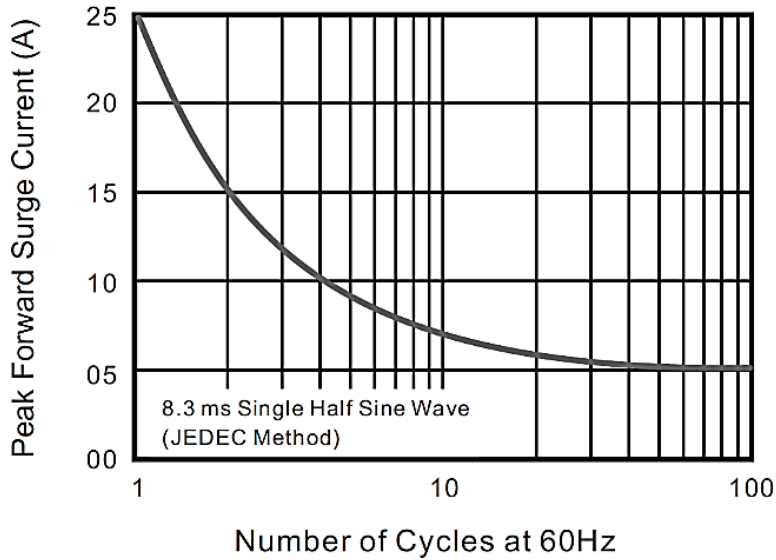
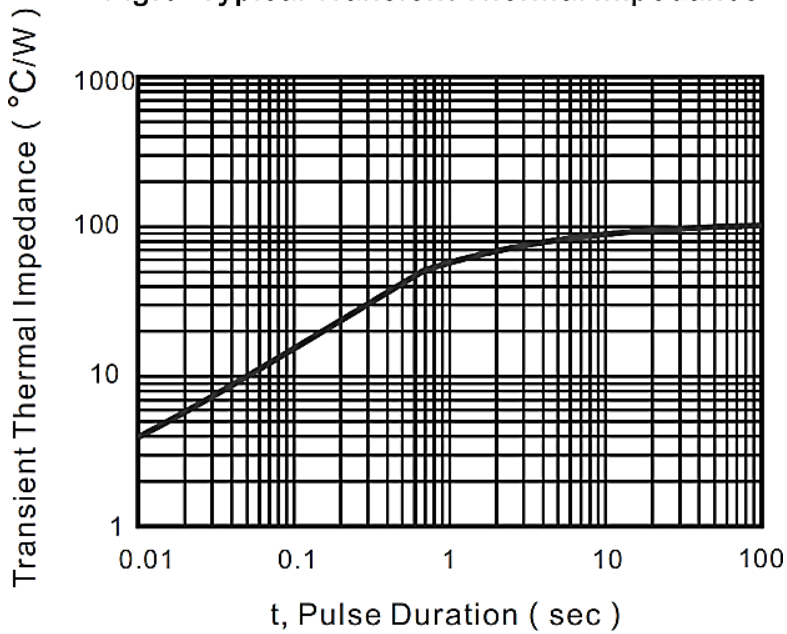
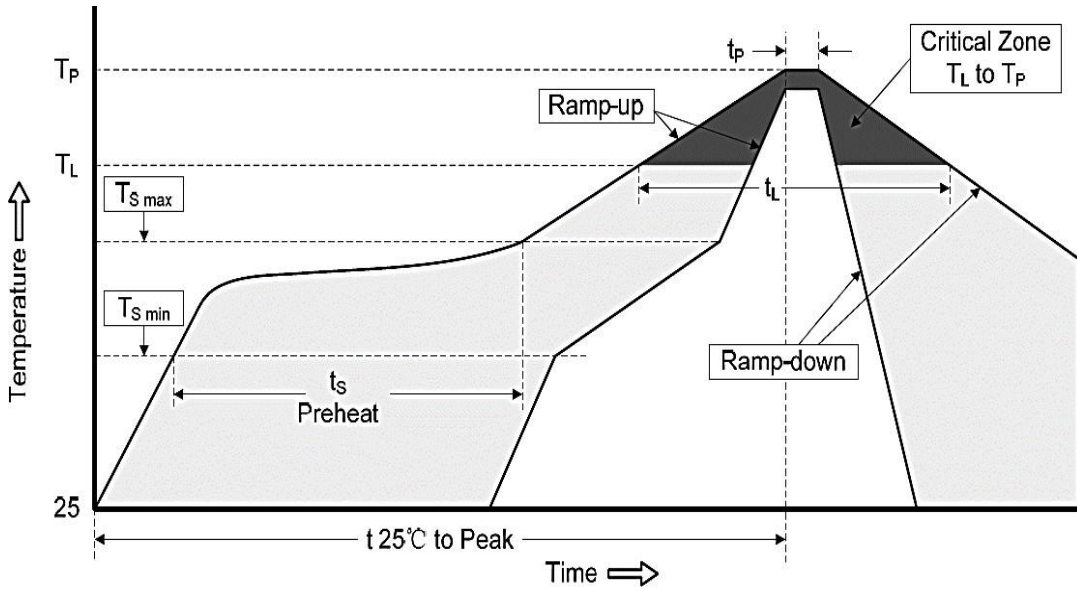

Fig.6- Typical Transient Thermal Impedance



SUGGESTED REFLOW PROFILE - For Reference Only



PROFILE FEATURE		PB-FREE ASSEMBLY
Average Ramp-up Rate (Ts Max to Tp)		3°C/second Max
Preheat	Temperature Min (Ts Min.)	150°C
	Temperature Max (Ts Max.)	200°C
	Time (ts Min. to ts Max.)	60 ~ 180 seconds
Time maintained above	Temperature (Tl)	217°C
	Time (tl)	60 ~ 150 seconds
Peak/Classification Temperature (Tp)		260 °C
Time within 5°C of actual Peak Temperature (tp)		20 ~ 40 seconds
Ramp-down rate		6 °C /Second Max.
Time 25 °C to Peak Temperature		8 minutes Max.
Suggest reflow times		3 Times Max.

TAPE AND REEL (Unit: mm)

- All Devices are packed in accordance with EIA standard RS-481-A and specifications.

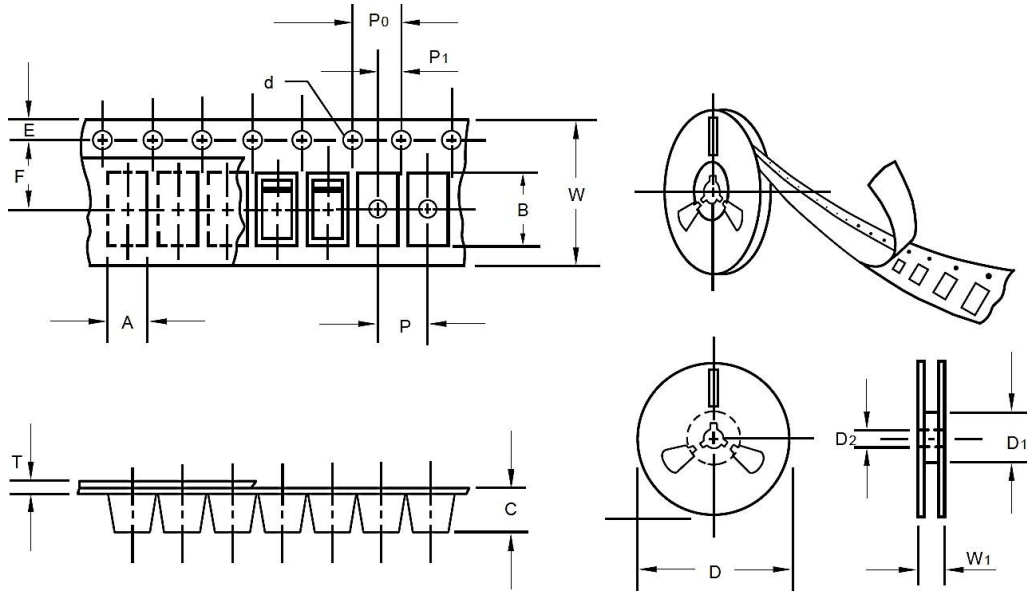

ITEM	SYMBOL	TOLERANCE	SOD-123FL
Carrier width	A	0.1	2.10
Carrier Length	B	0.1	4.00
Carrier Depth	C	0.1	1.60
Sprocket hole	d	0.05	1.55
7" Reel outside diameter	D	2.0	178.00
7" Reel inner diameter	D1	Min.	50.00
Feed hole diameter	D2	0.5	13.00
Sprocket hole position	E	0.1	1.75
Punch hole position	F	0.1	3.50
Punch hole pitch	P	0.1	4.00
Sprocket hole pitch	P0	0.1	4.00
Embossment center	P1	0.1	2.00
Overall tape thickness	T	0.1	0.25
Tape width	W	0.3	8.15
Reel width	W1	1.0	10.50
MPQ/Reel	3000pcs/Reel		

IMPORTANT NOTES AND DISCLAIMER

1. **ROHS COMPLIANCE:** The levels of RoHS restricted materials in this product are below the maximum concentration values (also referred to as the threshold limits) permitted for such substances, or are used in an exempted application, in accordance with EU RoHS Directive (EU) 2015/863 EC (RoHS3). RoHS Test Report for this product can be obtained can be obtained at Download Center.
2. **REACH COMPLIANCE:** REACH substances of high concern (SVHCs) information is available for this product. Since the European Chemical Agency (ECHA) has published notice of their intent to frequently revise the SVHC listing for the foreseeable future, REACH Test Report for this product can be obtained can be obtained at Download Center.
3. All Product parametric performance is indicated in the Electrical Characteristics for the listed herein test conditions, unless otherwise noted. Product performance may not be indicated by the Electrical Characteristics if operated under different conditions.
4. NextGen Component, Inc (*NextGen*) reserves the right to make changes to this document and its products and specifications at any time without notice. Customers should obtain and confirm the latest product information and specifications before final design, purchase or use.
5. *NextGen* makes no warranty, representation or guarantee regarding the suitability of its products for any particular purpose, not does *NextGen* assume any liability for application assistance or customer product design.
6. *NextGen* does not warrant or accept any liability with products which are purchased or used for any unintended or unauthorized application. No license is granted by implication or otherwise under any intellectual property rights of NextGen.
7. *NextGen* products are not authorized for use as critical components in life support devices or systems without express written approval by *NextGen*.
8. *NextGen* requires that customers first obtain an RMA (Returned Merchandise Authorization) number prior to returning any products. Returns must be made within 30 days of the date of invoice, be in the original packaging, unused and like-new condition. At the time of quoting or purchasing, a product may say that it is Non-Cancelable/ Non-Returnable (NCNR). These products are not returnable and not refundable.