



SPECIFICATION SHEET NO.	T0121- CA45LD010K227T	
ORIGINAL MFG/PART NO	XiangJiang/CA45L-D-10V220/CA45L-D010K227T/CA45L-D010K227T-E0K15	
NEXTGEN PART CODE	CA45LD010K227T	Indicate This Code For <a href="#">RFQ</a> /Order
DATE	Jan. 21, 2026	
REVISION	A3	Updated With Most Recent Data
DESCRIPTION AND MAIN PARAMETRICS	<p>SMD Standard Tantalum Capacitors Industrial Grade MnO<sub>2</sub>, CA45L Series  EIA code 7343-28 (2917), Case D, L7.30*W4.30*H2.80mm  Rated voltage 10 Vdc, Capacitance 220μF, Tolerance ±10%,  ESR 0.15Ω Max. Operating Temp. Range -55°C ~+125°C  Package in Tape/Reel, 500pcs/Reel  RoHS/RoHS III compliant, RoHS Annex III lead Exemption (Exempt per RoHS EU 2015/863) and Halogen Free (HF)</p>	
CUSTOMER		
CUSTOMER PART NUMBER		
CROSS REF. PART NUMBER	TPS/F91/TPM/T494/T495/T510/TSM/593D	
MEMO		

<b>VENDOR APPROVE</b>		
Issued/Checked/Approved		
		
Effective Date: Jan. 21, 2026		

<b>CUSTOMER APPROVE</b>	
DATE:	

## MAIN FEATURE

- Epoxy Molded Encapsulation, Chip, Small In Size, Light In Weight
- Easy For Integration, Heteroploidy
- Lower ESR Than The Standard Chip Tantalum Capacitor
- Stable In Electrical & Storage Performances, Long Life-span
- Executive Technical Standards: QJ/PWV305-2008
- Wide Operating Temperature Range -55 ~ +125°C
- Cross Most Competitors Parts TPS/F91/TPM/T494/T495/T510/TSM/593D and more
- Moisture Sensitivity Level (MSL) 1 (Unlimited)
- RoHS/RoHS III compliant, RoHS Annex III lead Exemption (Exempt per RoHS EU 2015/863) and Halogen Free (HF)



*Image shown is a representation only. Exact specifications should be obtained from the product dimension.*

## MAIN APPLICATION

- DC/DC Converters
- Portable Electronics
- Telecommunications And Control Units



## ELECTRICAL CHARACTERISTICS

- See Page 13 ~ Page 34 for Different Part Code
- All Products Parameters are Subject To NextGen Components' Final Confirmation.

## HOW TO ORDER

- Please Follow Up Part Code Guide And Indicate NextGen Part Code CA45LD010K227T For RFQ and Order.

## PART CODE GUIDE

**RFQ**  
[Request For Quotation](#)

CODE	NAME	KEY SPECIFICATION OPTION
CA45L	Product Series Code	SMD Low ESR Chip Tantalum Capacitors Industrial Grade MnO <sub>2</sub>
D	Case Size Code	A: 3216-16 (1206) L3.2*W1.6*H1.6mm; B: 3528-19 (1210) L3.5*W2.8*H1.9mm C: 6032-25 (2312) L6.0*W3.2*H2.5mm; D: 7343-28 (2917) L7.3*W4.3*H2.8mm E: 7343-43 (2917) L7.3*W4.3*H4.3mm; V: 7361-36 (2924) L7.3*W6.1*H3.6mm
010	Rated voltage Code	2R5: 2.5V; 004: 4V; 6R3: 6.3V; 010: 10V; 016: 16V; 020: 20V; 025: 25V; 035: 35V; 050: 50V 063: 63V 075: 75V 100: 100V
K	Capacitance Tolerance code	K: ±10% (Standard); M: ±20%
227	Capacitance Code	1st two digits represent Significant figures, 3rd Digit specifies number of Zeros 474: 0.47µF; 684:0.68µF; 105: 1.0µF; 155: 1.5µF; 225: 2.2µF; 335: 3.3µF; 475: 4.7µF; 685: 6.8µF; 106: 10µF; 156: 15µF; 226: 22µF; 336: 33µF; 476: 47µF; 686: 68µF; 107: 100µF; 157: 150µF; 227: 220µF; 337: 330µF; 477: 470µF; 687: 680µF; 108: 1000µF; 158: 1500µF; 228: 2200µF
T	Internal Control Code	Letter A~Z, a~z Or Digits (0-9)
XX	Special/ Custom Parameters	Blank: N/A; XX: Letter A~Z, a~z or digits (0~9) for Special/Custom Parameters

DIMENSIONS - - Unit: mm

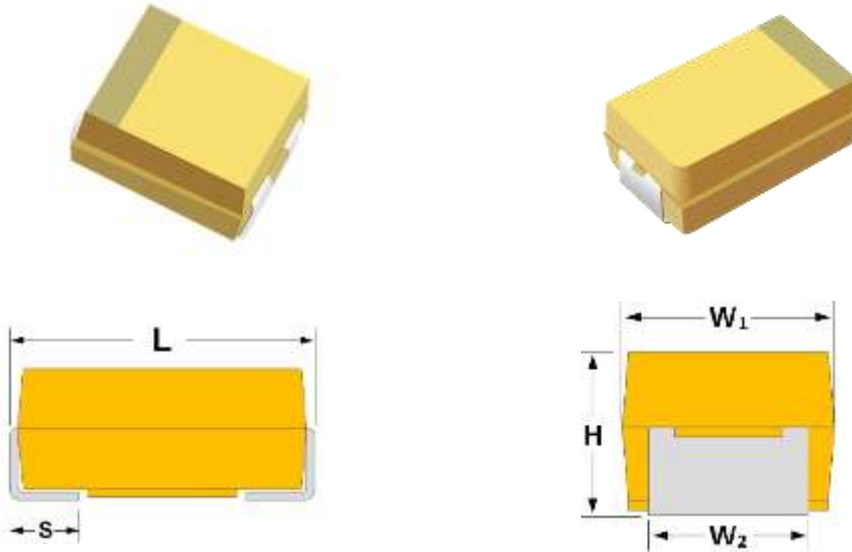

CASE SIZE CODE	EIA CODE	EIA METRIC	L	W <sub>1</sub>	H	S	W <sub>2</sub>
A	1206	3216-16	3.20±0.20	1.60±0.20	1.60±0.30	0.70±0.20	1.20±0.20
B	1210	3528-19	3.50±0.20	2.80±0.20	1.90±0.30	0.70±0.20	2.20±0.20
C	2312	6032-25	6.00±0.30	3.20±0.30	2.50±0.30	1.30±0.30	2.20±0.20
D	2917	7343-28	7.30±0.30	4.30±0.30	2.80±0.30	1.30±0.30	2.40±0.20
E	2917	7343-43	7.30±0.30	4.30±0.30	4.3±0.30	1.30±0.30	2.40±0.20
V	2924	7361-36	7.30±0.30	6.10±0.30	3.60±0.30	1.50±0.30	3.00±0.20

## LAND DIMENSIONS

Density Level A: For low-density product applications. Recommended for wave solder applications and provides a wider process window for reflow solder processes.

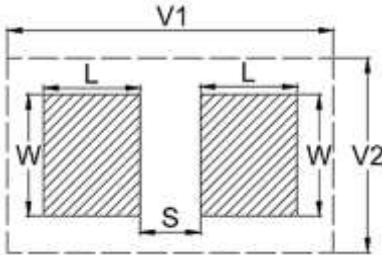

Note:

- Height of these chips may create problems in wave soldering.
- Land pattern geometry is too small for silkscreen outline.

CASE CODE	EIA METRIC	DIMENSION (MM)				
		W	L	S	V1	V2
A	3216-16	1.35	2.20	0.62	6.02	2.80
B1	3528-12	2.35	2.21	0.92	6.32	4.00
B	3528-19	2.35	2.21	0.92	6.32	4.00
C	6032-25	2.35	2.77	2.37	8.92	4.50
H1	7343-15	2.55	2.77	3.67	10.22	5.60
L	7343-19	2.55	2.77	3.67	10.22	5.60
H	7343-21	2.55	2.77	3.67	10.22	5.60
D	7343-28	2.55	2.77	3.67	10.22	5.60
Y	7343-40	2.55	2.77	3.67	10.22	5.60
E	7343-43	2.55	2.77	3.67	10.22	5.60
F	7361-19	3.25	2.77	3.67	10.22	7.30
V	7361-36	3.25	2.77	3.67	10.22	7.30
W	7361-41	3.25	2.77	3.67	10.22	7.30

### LAND DIMENSIONS

Density Level B: For products with a moderate level of component density. Provides Recommended Profile

Conditions for reflow solder processes.

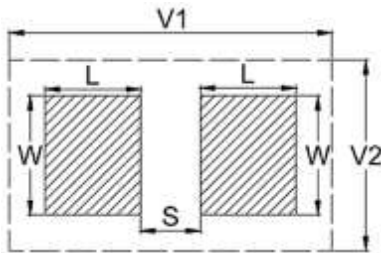

Note:

- Height of these chips may create problems in wave soldering.
- Land pattern geometry is too small for silkscreen outline.

CASE CODE	EIA METRIC	DIMENSION (MM)				
		W	L	S	V1	V2
A	3216-16	1.23	1.80	0.82	4.92	2.30
B1	3528-12	2.23	1.80	1.12	5.22	3.50
B	3528-19	2.23	1.80	1.12	5.22	3.50
C	6032-25	2.23	2.37	2.57	7.82	4.00
H1	7343-15	2.43	2.37	3.87	9.12	5.10
L	7343-19	2.43	2.37	3.87	9.12	5.10
H	7343-21	2.43	2.37	3.87	9.12	5.10
D	7343-28	2.43	2.37	3.87	9.12	5.10
Y	7343-40	2.43	2.37	3.87	9.12	5.10
E	7343-43	2.43	2.37	3.87	9.12	5.10
F	7361-19	3.13	2.37	3.87	9.12	6.80
V	7361-36	3.13	2.37	3.87	9.12	6.80
W	7361-41	3.13	2.37	3.87	9.12	6.80

## LAND DIMENSIONS

Density Level C: For high component density product applications. Before adapting the Min. land pattern variations, the user should perform qualification testing based on the conditions outlined in IPC - 7351).

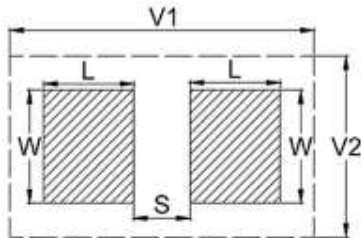

**Note:**

- Height of these chips may create problems in wave soldering.
- Land pattern geometry is too small for silkscreen outline.

CASE CODE	EIA METRIC	DIMENSION (MM)				
		W	L	S	V1	V2
A	3216-16	1.13	1.42	0.98	4.06	2.04
B1	3528-12	2.13	1.42	1.28	4.36	3.24
B	3528-19	2.13	1.42	1.28	4.36	3.24
C	6032-25	2.13	1.99	2.73	6.96	3.74
H1	7343-15	2.33	1.99	4.03	8.26	4.84
L	7343-19	2.33	1.99	4.03	8.26	4.84
H	7343-21	2.33	1.99	4.03	8.26	4.84
D	7343-28	2.33	1.99	4.03	8.26	4.84
Y	7343-40	2.33	1.99	4.03	8.26	4.84
E	7343-43	2.33	1.99	4.03	8.26	4.84
F	7361-19	3.03	1.99	4.03	8.26	6.54
V	7361-36	3.03	1.99	4.03	8.26	6.54
W	7361-41	3.03	1.99	4.03	8.26	6.54

**MARKING**

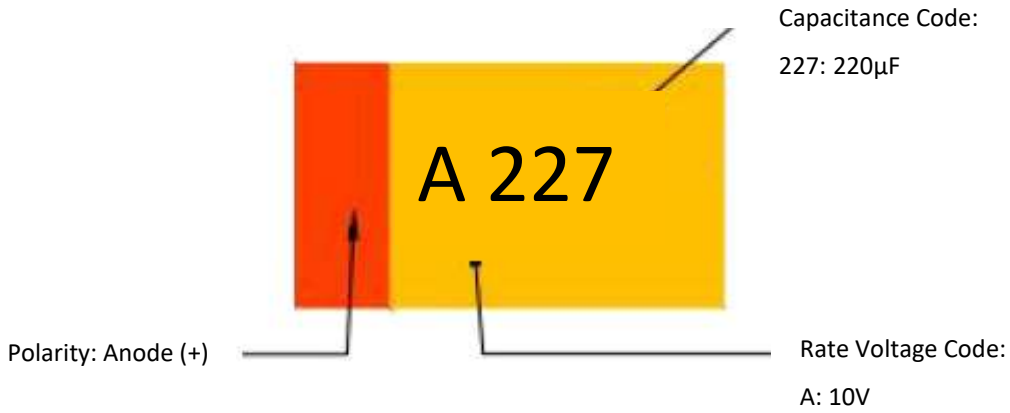

Voltage Code	F	G	J	A	C	D	E	V	T
Rate Voltage (V)	2.5	4.0	6.3	10	16	20	25	35	50

**MAXIMUM OPERATING AND SURGE VOLTAGES VS. TEMPERATURE**

Rate Voltage (V <sub>R</sub> )	≤ 85°C	2.5	4.0	6.3	10	16	20	25	35	50
Category Voltage (V <sub>C</sub> )	≤ 125°C	1.7	2.7	4.2	6.7	10.7	13.3	16.7	23.3	33.3
Surge Voltage (V <sub>S</sub> )	≤ 85°C	2.9	4.6	7.2	11.5	18.4	23.0	28.8	40.3	57.5
Surge Voltage (V <sub>S</sub> )	≤ 125°C	1.9	3.1	4.8	7.7	12.3	15.3	19.2	26.8	38.3

**BASIC INFORMATION**

ITEM	CHARACTERISTIC
Dielectric	Ta2O5
Electrolyte	MnO2
Package Method	Epoxy Resin Molding (Semi-Seal)
Case Color	Yellow (std.) or Black
MSL	1
Termination Finish	Standard Solder-coated, Gold-plated Option

**STANDARD CHARACTERISTICS**

PART CODE	CA45LD010K227T
Case Size Code	D
Case Dimension	L7.30*W4.30*H2.80mm
EIA Code	7343-28 (2917)
Capacitance Tolerance	±10%
Rate Temperature Range	85 °C
Category Voltage	6.7V
Category Temperature Range	125 °C
Operating Temperature Range	-55~ + 125 °C

CASE CODE, RATED VOLTAGE, CAPACITANCE AND ESR LIST

VOLTAGE CODE		F	G	J
Voltage (V)		2.5	4	6.3
Cap. Code	Cap.(µf)	Case Code (ESR mΩ)		
155	1.5			A (4000)
225	2.2			A (4000)
335	3.3			A (4000) B (2500)
475	4.7		B (1500)	A (4000) B (2500)
685	6.8		A (2000) B (1500)	A (1800) B (1500)
106	10		A (2500) B (2000)	A (1500) B (1500)
156	15		A (2500) B (2000) C (800)	A (1500) B (1000) C (500)
226	22		A (2500) B (2000) C (800)	A (1200) B (600) C (500)
336	33		A (2500) B (2000) C (800)	A (1200) B (600) C (400)
476	47		A (1500) B (900) C (500)	A (800) B (600) C (300)
686	68		A (1200) B (1000) C (600)	A (1500) B (600) C (250)
107	100	B (250)	A (1500) B(450) C (500)	A (1500) B (500) C (200)
157	150	B (250)	B (450) C (150) D (120)	B (500) C (250) D (125)
227	220	B (250) D (100)	B (400) C (250) D (150)	B (600) C (250) D (150)
337	330	D (100)	C (150) D (120) E (100)	C (150) D (100) E (100)
477	470	C (250) D (100)	C (150) D (120) E (100)	D (200) E (150) V (100)
687	680	C (250) D (100) E (100)	D (120) E (100)	E (150) V (100)
108	1000	D (100) E (100)	D (150) E (100) V (100)	E (100) V (100)
158	1500	D (100) E (100) V (100)	E (100) V (100)	
228	2200	V (100)		

CASE CODE, RATED VOLTAGE, CAPACITANCE AND ESR LIST

VOLTAGE CODE		A	C	D
Voltage (V)		10	16	20
Cap. Code	Cap.(μf)	Case Code (ESR mΩ)		
105	1	A (3000) B (2000)	A (4000) B(3000)	A (3000) B (2000)
155	1.5	A (3000)	A (4000) B(3000)	A (3000) B (2000)
225	2.2	A (3000) B (2000)	A (3500) B(2000)	A (3000) B (2000)
335	3.3	A (3000) B (2000)	A (3500) B(2500)	A (3000) B (1500) C (1000)
475	4.7	A (1600) B (1600)	A (2000) B(1500)	A (1800) B (1200) C (1000)
685	6.8	A (1800) B (1300) C (900)	A (2000) B(1200)	A (1200) B (1000) C (800)
106	10	A (1800) B (1000)	A (1500) B (800) C (500)	A (1500) B (1000) C (700)
156	15	A (1000) B (600) C (600)	A (2000) B (800) C (700)	B (800) C (500) D (500)
226	22	A (1200) B (800) C(400)	A (2500) B (700) C (500)	B (800) C (600) D (400)
336	33	A (1200) B (650) C(500)	B (800) C (350) D (350)	B (1500) C (400) D (300)
476	47	A (1200) B (650) C(400)	B (1500) C (350) D (300) E (200)	C (300) D (250) E (250)
686	68	B (600) C (300) D (150)	C (200) D (200) E (200)	C (400) D (250) E (250)
107	100	B (500) C (250) D (200)	C (200) D (150) E (150)	D (200) E (200) V (200)
157	150	C (150) D (150) E (150)	D (150) E (100) V (100)	E (180) V (100)
227	220	C (150) D (150) E (150)	D (200) E (200) V (200)	E (125) V (125)
337	330	D (150) E (100) V (100)	E (180) V (180)	E (125) V (125)
477	470	E (150) V (100)	E (150)	
687	680	E (150)		

CASE CODE, RATED VOLTAGE, CAPACITANCE AND ESR LIST

VOLTAGE CODE		E	V	T
Voltage (V)		25	35	50
Cap. Code	Cap.(µf)	Case Code (ESR mΩ)		
474	0.47	A (7000)	A (6000) B (4000)	A (6000) B (6000) C (3000)
684	0.68	A (6000) B (4000)	A (5000) B (3000)	A (6000) B (3000) C (3000)
105	1	A (4000) B (3000)	A (3000) B (2500)	A (5000) B (2500) C (1800)
155	1.5	A (3000) B (2000)	A (3000) B (2500) C (2500)	B (3000) C (1800) D (1000)
225	2.2	A (3000) B(2500) C (800)	A (3000) B (2500) C (1500)	B (2500) C (1500) D (700)
335	3.3	A (2000) B(2000) C (1200)	B (1500) C (1200)	C (700) D (700)
475	4.7	A (2000) B(1500) C (1000)	B (1800) C (800) D (700)	C (700) D (600)
685	6.8	B (2000) C(1500) D (1000)	C (600) D (600)	C (700) D (600) E (500)
106	10	B (1200) C(1000) D (700)	C (700) D (400) E (300)	D (500) E (500) V (500)
156	15	B (1500) C(900) D (450)	C (500) D (350) E (300)	E (300) V (300)
226	22	C (600) D (400)	D (400) E (300)	E (400) V (300)
336	33	D (300) E (250)	D (500) E (300) V (200)	
476	47	D (350) E (300)	D (400) E (400) V (300)	
686	68	D (300) E (250) V (250)	E (500) V (300)	
107	100	E (200) V (150)		
157	150	E (200) V (200)		

ELECTRONICAL CHARACTERISTICS- RATED VOLTAGE 2.5V, CAPACITANCE TOL. ±10% (K)

Part Code	Rate Voltage ≤ 85°C	Cap. @25°C 100Hz	Max. Leakage Current @+25°C 5 min.	Max. Dissipation Factor (DF) @25°C 100Hz	ESR @25°C 100 KHz	Max. Ripple Current		
						@ 25°C 100KHz	@ 85°C 100KHz	@ 125°C 100KHz
	V	µF	µA	%	Ω	mA		
CA45LB2R5K107T	2.5	100	2.5	8	0.25	583	525	233
CA45LB2R5K157T	2.5	150	3.8	10	0.25	583	525	233
CA45LB2R5K227T	2.5	220	5.5	16	0.25	583	525	233
CA45LD2R5K227T	2.5	220	5.5	8	0.1	1225	1102	490
CA45LD2R5K337T	2.5	330	8.3	8	0.1	1225	1102	490
CA45LC2R5K477T	2.5	470	12	12	0.25	663	597	265
CA45LD2R5K477T	2.5	470	12	8	0.1	1225	1102	490
CA45LC2R5K687T	2.5	680	17	18	0.25	663	597	265
CA45LD2R5K687T	2.5	680	17	16	0.1	1225	1102	490
CA45LE2R5K687T	2.5	680	17	10	0.1	1285	1156	514
CA45LD2R5K108T	2.5	1000	25	20	0.1	1225	1102	490
CA45LE2R5K108T	2.5	1000	25	14	0.1	1285	1156	514
CA45LD2R5K158T	2.5	1500	38	60	0.1	1225	1102	490
CA45LE2R5K158T	2.5	1500	38	20	0.1	1285	1156	514
CA45LV2R5K158T	2.5	1500	38	20	0.1	1581	1423	632
CA45LV2R5K228T	2.5	2200	55	50	0.1	1581	1423	632

**ELECTRONICAL CHARACTERISTICS- RATED VOLTAGE 4.0V, CAPACITANCE TOL. ±10% (K)**

Part Code	Rate Voltage ≤ 85°C	Cap. @25°C 100Hz	Max. Leakage Current @+25°C 5 min.	Max. Dissipation Factor (DF) @25°C 100Hz	ESR @25°C 100 KHz	Max. Ripple Current		
						@ 25°C 100KHz	@ 85°C 100KHz	@ 125°C 100KHz
	V	µF	µA	%	Ω	mA		
CA45LB004K475T	4	4.7	0.5	6	1.5	238	214	95
CA45LA004K685T	4	6.8	0.5	6	2	194	174	77
CA45LB004K685T	4	6.8	0.5	6	1.5	238	214	95
CA45LA004K106T	4	10	0.5	6	2.5	173	156	69
CA45LB004K106T	4	10	0.5	6	2	206	186	82
CA45LA004K156T	4	15	0.6	6	2.5	173	156	69
CA45LB004K156T	4	15	0.6	6	2	206	186	82
CA45LC004K156T	4	15	0.6	6	0.8	371	334	148
CA45LA004K226T	4	22	0.9	6	2.5	173	156	69
CA45LB004K226T	4	22	0.9	6	2	206	186	82
CA45LC004K226T	4	22	0.9	6	0.8	371	334	148
CA45LA004K336T	4	33	1.3	6	2.5	173	156	69
CA45LB004K336T	4	33	1.3	6	2	206	186	82
CA45LC004K336T	4	33	1.3	6	0.8	371	334	148
CA45LA004K476T	4	47	1.9	8	1.5	224	201	89
CA45LB004K476T	4	47	1.9	6	0.9	307	277	123
CA45LC004K476T	4	47	1.9	6	0.5	469	422	188
CA45LA004K686T	4	68	2.7	14	1.2	250	225	100
CA45LB004K686T	4	68	2.7	6	1	292	262	117
CA45LC004K686T	4	68	2.7	8	0.6	428	385	171

ELECTRONICAL CHARACTERISTICS- RATED VOLTAGE 4.0V, CAPACITANCE TOL. ±10% (K)

Part Code	Rate Voltage ≤ 85°C	Cap. @25°C 100Hz	Max. Leakage Current @+25°C 5 min.	Max. Dissipation Factor (DF) @25°C 100Hz	ESR @25°C 100 KHz	Max. Ripple Current		
						@ 25°C 100KHz	@ 85°C 100KHz	@ 125°C 100KHz
	V	µF	µA	%	Ω	mA		
CA45LA004K107T	4	100	4	18	1.5	224	201	89
CA45LB004K107T	4	100	4	14	0.45	435	391	174
CA45LC004K107T	4	100	4	8	0.5	469	422	188
CA45LB004K157T	4	150	6	16	0.45	435	391	174
CA45LC004K157T	4	150	6	8	0.15	856	771	343
CA45LD004K157T	4	150	6	8	0.12	1118	1006	447
CA45LB004K227T	4	220	8.8	18	0.4	461	415	184
CA45LC004K227T	4	220	8.8	10	0.25	663	597	265
CA45LD004K227T	4	220	8.8	8	0.15	1000	900	400
CA45LC004K337T	4	330	13	10	0.15	856	771	343
CA45LD004K337T	4	330	13	8	0.12	1118	1006	447
CA45LE004K337T	4	330	13	8	0.1	1285	1156	514
CA45LC004K477T	4	470	19	14	0.15	856	771	343
CA45LD004K477T	4	470	19	12	0.12	1118	1006	447
CA45LE004K477T	4	470	19	10	0.1	1285	1156	514
CA45LD004K687T	4	680	27	14	0.12	1118	1006	447
CA45LE004K687T	4	680	27	14	0.1	1285	1156	514
CA45LD004K108T	4	1000	40	60	0.15	1000	900	400
CA45LE004K108T	4	1000	40	14	0.1	1285	1156	514
CA45LV004K108T	4	1000	40	16	0.1	1581	1423	632



**ELECTRONICAL CHARACTERISTICS- RATED VOLTAGE 6.3V, CAPACITANCE TOL. ±10% (K)**

Part Code	Rate Voltage ≤ 85°C	Cap. @25°C 100Hz	Max. Leakage Current @+25°C 5 min.	Max. Dissipation Factor (DF) @25°C 100Hz	ESR @25°C 100 KHz	Max. Ripple Current		
						@ 25°C 100KHz	@ 85°C 100KHz	@ 125°C 100KHz
	V	µF	µA	%	Ω	mA		
CA45LA6R3K155T	6.3	1.5	0.5	6	4	137	123	55
CA45LA6R3K225T	6.3	2.2	0.5	6	4	137	123	55
CA45LA6R3K335T	6.3	3.3	0.5	6	4	137	123	55
CA45LB6R3K335T	6.3	3.3	0.5	6	2.5	184	166	74
CA45LA6R3K475T	6.3	4.7	0.5	6	4	137	123	55
CA45LB6R3K475T	6.3	4.7	0.5	6	2.5	184	166	74
CA45LA6R3K685T	6.3	6.8	0.5	6	1.8	204	184	82
CA45LB6R3K685T	6.3	6.8	0.5	6	1.5	238	214	95
CA45LA6R3K106T	6.3	10	0.6	6	1.5	224	201	89
CA45LB6R3K106T	6.3	10	0.6	6	1.5	238	214	95
CA45LA6R3K156T	6.3	15	0.9	6	1.5	224	201	89
CA45LB6R3K156T	6.3	15	0.9	6	1	292	262	117
CA45LC6R3K156T	6.3	15	0.9	6	0.5	469	422	188
CA45LA6R3K226T	6.3	22	1.4	8	1.2	250	225	100
CA45LB6R3K226T	6.3	22	1.4	6	0.6	376	339	151
CA45LC6R3K226T	6.3	22	1.4	6	0.5	469	422	188
CA45LA6R3K336T	6.3	33	2.1	8	1.2	250	225	100
CA45LB6R3K336T	6.3	33	2.1	6	0.6	376	339	151
CA45LC6R3K336T	6.3	33	2.1	6	0.4	524	472	210
CA45LA6R3K476T	6.3	47	3	10	0.8	306	276	122

ELECTRONICAL CHARACTERISTICS- RATED VOLTAGE 6.3V, CAPACITANCE TOL. ±10% (K)

Part Code	Rate Voltage ≤ 85°C	Cap. @25°C 100Hz	Max. Leakage Current @+25°C 5 min.	Max. Dissipation Factor (DF) @25°C 100Hz	ESR @25°C 100 KHz	Max. Ripple Current		
						@ 25°C 100KHz	@ 85°C 100KHz	@ 125°C 100KHz
	V	µF	µA	%	Ω	mA		
CA45LB6R3K476T	6.3	47	3	8	0.6	376	339	151
CA45LC6R3K476T	6.3	47	3	6	0.3	606	545	242
CA45LA6R3K686T	6.3	68	4.3	14	1.5	224	201	89
CA45LB6R3K686T	6.3	68	4.3	10	0.6	376	339	151
CA45LC6R3K686T	6.3	68	4.3	8	0.25	663	597	265
CA45LA6R3K107T	6.3	100	6.3	26	1.5	224	201	89
CA45LB6R3K107T	6.3	100	6.3	14	0.5	412	371	165
CA45LC6R3K107T	6.3	100	6.3	8	0.2	742	667	297
CA45LB6R3K157T	6.3	150	9.5	18	0.5	412	371	165
CA45LC6R3K157T	6.3	150	9.5	10	0.25	663	597	265
CA45LD6R3K157T	6.3	150	9.5	8	0.125	1095	986	438
CA45LB6R3K227T	6.3	220	14	18	0.6	376	339	151
CA45LC6R3K227T	6.3	220	14	18	0.25	663	597	265
CA45LD6R3K227T	6.3	220	14	8	0.15	1000	900	400
CA45LC6R3K337T	6.3	330	21	14	0.15	856	771	343
CA45LD6R3K337T	6.3	330	21	10	0.1	1225	1102	490
CA45LE6R3K337T	6.3	330	21	8	0.1	1285	1156	514
CA45LD6R3K477T	6.3	470	30	14	0.2	866	779	346
CA45LE6R3K477T	6.3	470	30	10	0.15	1049	944	420
CA45LV6R3K477T	6.3	470	30	10	0.1	1581	1423	632



ELECTRONICAL CHARACTERISTICS- RATED VOLTAGE 10V, CAPACITANCE TOL. ±10% (K)

Part Code	Rate Voltage ≤ 85°C	Cap. @25°C 100Hz	Max. Leakage Current @+25°C 5 min.	Max. Dissipation Factor (DF) @25°C 100Hz	ESR @25°C 100 KHz	Max. Ripple Current		
						@ 25°C 100KHz	@ 85°C 100KHz	@ 125°C 100KHz
	V	µF	µA	%	Ω	mA		
CA45LA010K105T	10	1	0.5	4	3	158	142	63
CA45LB010K105T	10	1	0.5	4	2	206	186	82
CA45LA010K155T	10	1.5	0.5	6	3	158	142	63
CA45LA010K225T	10	2.2	0.5	6	3	158	142	63
CA45LB010K225T	10	2.2	0.5	6	2	206	186	82
CA45LA010K335T	10	3.3	0.5	6	3	158	142	63
CA45LB010K335T	10	3.3	0.5	6	2	206	186	82
CA45LA010K475T	10	4.7	0.5	6	1.6	217	195	87
CA45LB010K475T	10	4.7	0.5	6	1.6	230	207	92
CA45LA010K685T	10	6.8	0.7	6	1.8	204	184	82
CA45LB010K685T	10	6.8	0.7	6	1.3	256	230	102
CA45LC010K685T	10	6.8	0.7	6	0.9	350	315	140
CA45LA010K106T	10	10	1	6	1.8	204	184	82
CA45LB010K106T	10	10	1	6	1	292	262	117
CA45LA010K156T	10	15	1.5	6	1	274	246	110
CA45LB010K156T	10	15	1.5	6	0.6	376	339	151
CA45LC010K156T	10	15	1.5	6	0.6	428	385	171
CA45LA010K226T	10	22	2.2	8	1.2	250	225	100
CA45LB010K226T	10	22	2.2	6	0.8	326	293	130
CA45LC010K226T	10	22	2.2	6	0.4	524	472	210

ELECTRONICAL CHARACTERISTICS- RATED VOLTAGE 10V, CAPACITANCE TOL. ±10% (K)

Part Code	Rate Voltage ≤ 85°C	Cap. @25°C 100Hz	Max. Leakage Current @+25°C 5 min.	Max. Dissipation Factor (DF) @25°C 100Hz	ESR @25°C 100 KHz	Max. Ripple Current		
						@ 25°C 100KHz	@ 85°C 100KHz	@ 125°C 100KHz
	V	µF	µA	%	Ω	mA		
CA45LA010K336T	10	33	3.3	14	1.2	250	225	100
CA45LB010K336T	10	33	3.3	6	0.65	362	325	145
CA45LC010K336T	10	33	3.3	6	0.5	469	422	188
CA45LA010K476T	10	47	4.7	26	1.2	250	225	100
CA45LB010K476T	10	47	4.7	8	0.65	362	325	145
CA45LC010K476T	10	47	4.7	6	0.4	524	472	210
CA45LB010K686T	10	68	6.8	10	0.6	376	339	151
CA45LC010K686T	10	68	6.8	6	0.3	606	545	242
CA45LD010K686T	10	68	6.8	6	0.15	1000	900	400
CA45LB010K107T	10	100	10	18	0.5	412	371	165
CA45LC010K107T	10	100	10	8	0.25	663	597	265
CA45LD010K107T	10	100	10	8	0.2	866	779	346
CA45LC010K157T	10	150	15	10	0.15	856	771	343
CA45LD010K157T	10	150	15	8	0.15	1000	900	400
CA45LE010K157T	10	150	15	8	0.15	1049	944	420
CA45LC010K227T	10	220	22	16	0.15	856	771	343
<b>CA45LD010K227T</b>	<b>10</b>	<b>220</b>	<b>22</b>	<b>8</b>	<b>0.15</b>	<b>1000</b>	<b>900</b>	<b>400</b>
CA45LE010K227T	10	220	22	8	0.15	1049	944	420
CA45LD010K337T	10	330	33	14	0.15	1000	900	400
CA45LE010K337T	10	330	33	8	0.1	1285	1156	514



**ELECTRONICAL CHARACTERISTICS- RATED VOLTAGE 16V, CAPACITANCE TOL. ±10% (K)**

Part Code	Rate Voltage ≤ 85°C	Cap. @25°C 100Hz	Max. Leakage Current @+25°C 5 min.	Max. Dissipation Factor (DF) @25°C 100Hz	ESR @25°C 100 KHz	Max. Ripple Current		
						@ 25°C 100KHz	@ 85°C 100KHz	@ 125°C 100KHz
	V	µF	µA	%	Ω	mA		
CA45LA016K105T	16	1	0.5	4	4	137	123	55
CA45LB016K105T	16	1	0.5	4	3	168	151	67
CA45LA016K155T	16	1.5	0.5	6	4	137	123	55
CA45LB016K155T	16	1.5	0.5	6	3	168	151	67
CA45LA016K225T	16	2.2	0.5	6	3.5	146	132	59
CA45LB016K225T	16	2.2	0.5	6	2	206	186	82
CA45LA016K335T	16	3.3	0.5	6	3.5	146	132	59
CA45LB016K335T	16	3.3	0.5	6	2.5	184	166	74
CA45LA016K475T	16	4.7	0.8	6	2	194	174	77
CA45LB016K475T	16	4.7	0.8	6	1.5	238	214	95
CA45LA016K685T	16	6.8	1.1	6	2	194	174	77
CA45LB016K685T	16	6.8	1.1	6	1.2	266	240	106
CA45LA016K106T	16	10	1.6	6	1.5	224	201	89
CA45LB016K106T	16	10	1.6	6	0.8	326	293	130
CA45LC016K106T	16	10	1.6	6	0.5	469	422	188
CA45LA016K156T	16	15	2.4	6	2	194	174	77
CA45LB016K156T	16	15	2.4	6	0.8	326	293	130
CA45LC016K156T	16	15	2.4	6	0.7	396	357	159
CA45LA016K226T	16	22	3.5	16	2.5	173	156	69
CA45LB016K226T	16	22	3.5	6	0.7	348	314	139

**ELECTRONICAL CHARACTERISTICS- RATED VOLTAGE 16V, CAPACITANCE TOL. ±10% (K)**

Part Code	Rate Voltage ≤ 85°C	Cap. @25°C 100Hz	Max. Leakage Current @+25°C 5 min.	Max. Dissipation Factor (DF) @25°C 100Hz	ESR @25°C 100 KHz	Max. Ripple Current		
						@ 25°C 100KHz	@ 85°C 100KHz	@ 125°C 100KHz
	V	µF	µA	%	Ω	mA		
CA45LC016K226T	16	22	3.5	6	0.5	469	422	188
CA45LB016K336T	16	33	5.3	8	0.8	326	293	130
CA45LC016K336T	16	33	5.3	6	0.35	561	505	224
CA45LD016K336T	16	33	5.3	6	0.35	655	589	262
CA45LB016K476T	16	47	7.5	14	1.5	238	214	95
CA45LC016K476T	16	47	7.5	6	0.35	561	505	224
CA45LD016K476T	16	47	7.5	6	0.3	707	636	283
CA45LE016K476T	16	47	7.5	6	0.2	908	817	363
CA45LC016K686T	16	68	11	6	0.2	742	667	297
CA45LD016K686T	16	68	11	6	0.2	866	779	346
CA45LE016K686T	16	68	11	6	0.2	908	817	363
CA45LC016K107T	16	100	16	12	0.2	742	667	297
CA45LD016K107T	16	100	16	8	0.15	1000	900	400
CA45LE016K107T	16	100	16	6	0.15	1049	944	420
CA45LD016K157T	16	150	24	8	0.15	1000	900	400
CA45LE016K157T	16	150	24	8	0.1	1285	1156	514
CA45LV016K157T	16	150	24	8	0.1	1581	1423	632
CA45LD016K227T	16	220	35	14	0.2	866	779	346
CA45LE016K227T	16	220	35	10	0.2	908	817	363
CA45LV016K227T	16	220	35	8	0.2	1118	1006	447



**ELECTRONICAL CHARACTERISTICS- RATED VOLTAGE 20V, CAPACITANCE TOL. ±10% (K)**

Part Code	Rate Voltage ≤ 85°C	Cap. @25°C 100Hz	Max. Leakage Current @+25°C 5 min.	Max. Dissipation Factor (DF) @25°C 100Hz	ESR @25°C 100 KHz	Max. Ripple Current		
						@ 25°C 100KHz	@ 85°C 100KHz	@ 125°C 100KHz
	V	µF	µA	%	Ω	mA		
CA45LA020K105T	20	1	0.5	4	3	158	142	63
CA45LB020K105T	20	1	0.5	4	2	206	186	82
CA45LA020K155T	20	1.5	0.5	6	3	158	142	63
CA45LB020K155T	20	1.5	0.5	6	2	206	186	82
CA45LA020K225T	20	2.2	0.5	6	3	158	142	63
CA45LB020K225T	20	2.2	0.5	6	2	206	186	82
CA45LA020K335T	20	3.3	0.7	6	3	158	142	63
CA45LB020K335T	20	3.3	0.7	6	1.5	238	214	95
CA45LC020K335T	20	3.3	0.7	6	1	332	298	133
CA45LA020K475T	20	4.7	0.9	6	1.8	204	184	82
CA45LB020K475T	20	4.7	0.9	6	1.2	266	240	106
CA45LC020K475T	20	4.7	0.9	6	1	332	298	133
CA45LA020K685T	20	6.8	1.4	6	1.2	250	225	100
CA45LB020K685T	20	6.8	1.4	6	1	292	262	117
CA45LC020K685T	20	6.8	1.4	6	0.8	371	334	148
CA45LA020K106T	20	10	2	10	1.5	224	201	89
CA45LB020K106T	20	10	2	6	1	292	262	117
CA45LC020K106T	20	10	2	6	0.7	396	357	159
CA45LB020K156T	20	15	3	6	0.8	326	293	130
CA45LC020K156T	20	15	3	6	0.5	469	422	188

ELECTRONICAL CHARACTERISTICS- RATED VOLTAGE 20V, CAPACITANCE TOL. ±10% (K)

Part Code	Rate Voltage ≤ 85°C	Cap. @25°C 100Hz	Max. Leakage Current @+25°C 5 min.	Max. Dissipation Factor (DF) @25°C 100Hz	ESR @25°C 100 KHz	Max. Ripple Current		
						@ 25°C 100KHz	@ 85°C 100KHz	@ 125°C 100KHz
	V	µF	µA	%	Ω	mA		
CA45LD020K156T	20	15	3	6	0.5	548	493	219
CA45LB020K226T	20	22	4.4	6	0.8	326	293	130
CA45LC020K226T	20	22	4.4	6	0.6	428	385	171
CA45LD020K226T	20	22	4.4	6	0.4	612	551	245
CA45LB020K336T	20	33	6.6	8	1.5	316	285	126
CA45LC020K336T	20	33	6.6	6	0.4	524	472	210
CA45LD020K336T	20	33	6.6	6	0.3	707	636	283
CA45LC020K476T	20	47	9.4	8	0.3	606	545	242
CA45LD020K476T	20	47	9.4	6	0.25	775	697	310
CA45LE020K476T	20	47	9.4	6	0.25	812	731	325
CA45LC020K686T	20	68	14	8	0.4	524	472	210
CA45LD020K686T	20	68	14	6	0.25	775	697	310
CA45LE020K686T	20	68	14	6	0.25	812	731	325
CA45LD020K107T	20	100	20	6	0.2	866	779	346
CA45LE020K107T	20	100	20	6	0.2	908	817	363
CA45LV020K107T	20	100	20	8	0.2	1118	1006	447
CA45LE020K157T	20	150	30	8	0.18	957	862	383
CA45LV020K157T	20	150	30	8	0.1	1581	1423	632
CA45LE020K227T	20	220	44	12	0.125	1149	1034	460
CA45LV020K227T	20	220	44	12	0.125	1414	1273	566



**ELECTRONICAL CHARACTERISTICS- RATED VOLTAGE 25V, CAPACITANCE TOL. ±10% (K)**

Part Code	Rate Voltage ≤ 85°C	Cap. @25°C 100Hz	Max. Leakage Current @+25°C 5 min.	Max. Dissipation Factor (DF) @25°C 100Hz	ESR @25°C 100 KHz	Max. Ripple Current		
						@ 25°C 100KHz	@ 85°C 100KHz	@ 125°C 100KHz
	V	µF	µA	%	Ω	mA		
CA45LA025K474T	25	0.47	0.5	4	7	104	93	41
CA45LA025K684T	25	0.68	0.5	4	6	112	101	45
CA45LB025K684T	25	0.68	0.5	4	4	146	131	58
CA45LA025K105T	25	1	0.5	4	4	137	123	55
CA45LB025K105T	25	1	0.5	4	3	168	151	67
CA45LA025K155T	25	1.5	0.5	6	3	158	142	63
CA45LB025K155T	25	1.5	0.5	6	2	206	186	82
CA45LA025K225T	25	2.2	0.6	6	3	158	142	63
CA45LB025K225T	25	2.2	0.6	6	2.5	184	166	74
CA45LC025K225T	25	2.2	0.6	6	0.8	371	334	148
CA45LA025K335T	25	3.3	0.8	6	2	194	174	77
CA45LB025K335T	25	3.3	0.8	6	2	206	186	82
CA45LC025K335T	25	3.3	0.8	6	1.2	303	272	121
CA45LA025K475T	25	4.7	1.2	6	2	194	174	77
CA45LB025K475T	25	4.7	1.2	6	1.5	238	214	95
CA45LC025K475T	25	4.7	1.2	6	1	332	298	133
CA45LB025K685T	25	6.8	1.7	6	1.2	266	240	106
CA45LC025K685T	25	6.8	1.7	6	1	332	298	133
CA45LD025K685T	25	6.8	1.7	6	0.7	463	417	185
CA45LB025K106T	25	10	2.5	6	1.5	238	214	95

**ELECTRONICAL CHARACTERISTICS- RATED VOLTAGE 25V, CAPACITANCE TOL. ±10% (K)**

Part Code	Rate Voltage ≤ 85°C	Cap. @25°C 100Hz	Max. Leakage Current @+25°C 5 min.	Max. Dissipation Factor (DF) @25°C 100Hz	ESR @25°C 100 KHz	Max. Ripple Current		
						@ 25°C 100KHz	@ 85°C 100KHz	@ 125°C 100KHz
	V	µF	µA	%	Ω	mA		
CA45LC025K106T	25	10	2.5	6	0.9	350	315	140
CA45LD025K106T	25	10	2.5	6	0.45	577	520	231
CA45LB025K156T	25	15	3.8	6	1.5	238	214	95
CA45LC025K156T	25	15	3.8	6	0.5	469	422	188
CA45LD025K156T	25	15	3.8	6	0.4	612	551	245
CA45LC025K226T	25	22	5.5	6	0.6	428	385	171
CA45LD025K226T	25	22	5.5	6	0.4	612	551	245
CA45LD025K336T	25	33	8.3	6	0.3	707	636	283
CA45LE025K336T	25	33	8.3	6	0.25	812	731	325
CA45LD025K476T	25	47	12	6	0.35	655	589	262
CA45LE025K476T	25	47	12	6	0.3	742	667	297
CA45LD025K686T	25	68	17	6	0.3	707	636	283
CA45LE025K686T	25	68	17	6	0.25	812	731	325
CA45LV025K686T	25	68	17	6	0.25	1000	900	400
CA45LE025K107T	25	100	25	10	0.2	908	817	363
CA45LV025K107T	25	100	25	8	0.15	1291	1162	516
CA45LE025K157T	25	150	38	8	0.2	908	817	363
CA45LV025K157T	25	150	38	10	0.2	1118	1006	447

**ELECTRONICAL CHARACTERISTICS- RATED VOLTAGE 35V, CAPACITANCE TOL. ±10% (K)**

Part Code	Rate Voltage ≤ 85°C	Cap. @25°C 100Hz	Max. Leakage Current @+25°C 5 min.	Max. Dissipation Factor (DF) @25°C 100Hz	ESR @25°C 100 KHz	Max. Ripple Current		
						@ 25°C 100KHz	@ 85°C 100KHz	@ 125°C 100KHz
	V	µF	µA	%	Ω	mA		
CA45LA035K474T	35	0.47	0.5	4	6	112	101	45
CA45LB035K474T	35	0.47	0.5	4	4	146	131	58
CA45LA035K684T	35	0.68	0.5	4	5	122	110	49
CA45LB035K684T	35	0.68	0.5	4	3	168	151	67
CA45LA035K105T	35	1	0.5	4	3	158	142	63
CA45LB035K105T	35	1	0.5	4	2.5	184	166	74
CA45LA035K155T	35	1.5	0.5	6	3	158	142	63
CA45LB035K155T	35	1.5	0.5	6	2.5	184	166	74
CA45LC035K155T	35	1.5	0.5	6	2.5	210	189	84
CA45LA035K225T	35	2.2	0.8	6	3	158	142	63
CA45LB035K225T	35	2.2	0.8	6	2.5	184	166	74
CA45LC035K225T	35	2.2	0.8	6	1.5	271	244	108
CA45LB035K335T	35	3.3	1.2	6	1.5	238	214	95
CA45LC035K335T	35	3.3	1.2	6	1.2	303	272	121
CA45LB035K475T	35	4.7	1.6	6	1.8	217	196	87
CA45LC035K475T	35	4.7	1.6	6	0.8	371	334	148
CA45LD035K475T	35	4.7	1.6	6	0.7	463	417	185
CA45LC035K685T	35	6.8	2.4	6	0.6	428	385	171
CA45LD035K685T	35	6.8	2.4	6	0.6	500	450	200
CA45LC035K106T	35	10	3.5	6	0.7	396	357	159

ELECTRONICAL CHARACTERISTICS- RATED VOLTAGE 35V, CAPACITANCE TOL. ±10% (K)

Part Code	Rate Voltage ≤ 85°C	Cap. @25°C 100Hz	Max. Leakage Current @+25°C 5 min.	Max. Dissipation Factor (DF) @25°C 100Hz	ESR @25°C 100 KHz	Max. Ripple Current		
						@ 25°C 100KHz	@ 85°C 100KHz	@ 125°C 100KHz
	V	µF	µA	%	Ω	mA		
CA45LD035K106T	35	10	3.5	6	0.4	612	551	245
CA45LE035K106T	35	10	3.5	6	0.3	742	667	297
CA45LC035K156T	35	15	5.3	6	0.5	469	422	188
CA45LD035K156T	35	15	5.3	6	0.35	655	589	262
CA45LE035K156T	35	15	5.3	6	0.3	742	667	297
CA45LD035K226T	35	22	7.7	6	0.4	612	551	245
CA45LE035K226T	35	22	7.7	6	0.3	742	667	297
CA45LD035K336T	35	33	12	6	0.5	548	493	219
CA45LE035K336T	35	33	12	6	0.3	742	667	297
CA45LV035K336T	35	33	12	6	0.2	1118	1006	447
CA45LD035K476T	35	47	16	10	0.4	612	551	245
CA45LE035K476T	35	47	16	10	0.4	642	578	257
CA45LV035K476T	35	47	16	8	0.3	913	822	365
CA45LE035K686T	35	68	24	6	0.5	574	517	230
CA45LV035K686T	35	68	24	6	0.3	913	822	365
CA45LE035M476T	35	47±20%	16	10	0.4	642	578	257

ELECTRONICAL CHARACTERISTICS- RATED VOLTAGE 50V, CAPACITANCE TOL. ±10% (K)

Part Code	Rate Voltage ≤ 85°C	Cap. @25°C 100Hz	Max. Leakage Current @+25°C 5 min.	Max. Dissipation Factor (DF) @25°C 100Hz	ESR @25°C 100 KHz	Max. Ripple Current		
						@ 25°C 100KHz	@ 85°C 100KHz	@ 125°C 100KHz
	V	µF	µA	%	Ω	mA		
CA45LA050K474T	50	0.47	0.5	4	6	119	107	48
CA45LB050K474T	50	0.47	0.5	4	6	119	107	48
CA45LC050K474T	50	0.47	0.5	4	3	191	172	77
CA45LA050K684T	50	0.68	0.5	4	6	112	101	45
CA45LB050K684T	50	0.68	0.5	4	3	168	151	67
CA45LC050K684T	50	0.68	0.5	4	3	191	172	77
CA45LA050K105T	50	1	0.5	4	5	122	110	49
CA45LB050K105T	50	1	0.5	6	2.5	184	166	74
CA45LC050K105T	50	1	0.5	4	1.8	247	222	99
CA45LB050K155T	50	1.5	0.8	8	3	168	151	67
CA45LC050K155T	50	1.5	0.8	6	1.8	247	222	99
CA45LD050K155T	50	1.5	0.8	6	1	387	349	155
CA45LB050K225T	50	2.2	1.1	8	2.5	184	166	74
CA45LC050K225T	50	2.2	1.1	8	1.5	271	244	108
CA45LD050K225T	50	2.2	1.1	6	0.7	463	417	185
CA45LC050K335T	50	3.3	1.7	6	0.7	396	357	159
CA45LD050K335T	50	3.3	1.7	6	0.7	463	417	185
CA45LC050K475T	50	4.7	2.4	6	0.7	396	357	159
CA45LD050K475T	50	4.7	2.4	6	0.6	500	450	200
CA45LC050K685T	50	6.8	3.4	6	0.7	396	357	159



**APPLICATION NTOE**

**STORAGE CONDITION**

- Environmental temperature: 10°C ~ +30°C
- Relative humidity no more than 60%
- Storing period: No more than one and half year since the date of stocking.

**APPLICATION GUIDE**

1) Ripple Current and Voltage

If the ripple current is applied to the capacitor, the Joule heat (power dissipated) will be generated in the capacitor, so it will affect the reliability of the capacitor.

(1) Power Dissipated

The actual power dissipated can be calculated using the following formula:  $P=I^2 \times ESR$ .....Formula 1

P: Power dissipated (W); I: Ripple current (A); ESR: Equivalent series resistance ( $\Omega$ )

(2) Ripple Current

Using the maximum power dissipation 125mW Max., the ripple current can be calculated using the following

formula:  $I= \sqrt{\frac{P}{ESR}} \times K \times F$ .....Formula 2

K: Temperature derating factor..... Table 1; F: Frequency derating factor..... Table 2

ESR: Refer to the ratings of each specific product

Table 1: Temperature Drop Factor K

Temperature	Temperature Derating Factor K
25 °C	1
85 °C	0.9
125 °C	0.4

Table 2: Frequency Derating Factor F

Frequency (KHz)	10	100	500	1000
MnO2	0.80	1.0	1.15	1.20
Polymer	0.75	1.0	1.10	1.30

### (3) Ripple Voltage

The ripple voltage applied to the capacitor is limited by three criteria.

- (a) The power dissipation in the ESR of capacitor must not exceed 125mW Max. @+25°C
- (b) The positive peak AC voltage plus the DC bias voltage must not exceed the DC voltage rating of the capacitor.
- (c) The negative peak AC voltage, in combination with the bias voltage, if any , must not exceed the permissible reverse voltage ratings presented .

### 2) Reverse Voltage

Solid tantalum capacitors are polarized devices , and applied reverse voltage can not be allowed . If the reverse voltage is unavoidable, a small degree of transient reverse voltage is permissible for short periods as follow.

25°C..... 10% of Max. rated voltage or 1V whichever is smaller

85°C..... 5% of Max. rated voltage or 0.5V whichever is smaller

125°C.....1% of Max. rated voltage or 0.1V whichever is smaller

Even under these restrictions, capacitors can not be used continuously in reverse voltage mode.

### 3) Working Voltage

- (1) For general applications, using 50% of rated voltage of capacitors or less.
- (2) When used at the power circuit, low impedance circuit , coupling circuit or witching circuit which has leakage current problems, please design the circuit with voltage under 30% of the working voltage ( max 50%) to avoid the adverse effect of the surge current.
- (3) Derating voltage when temperature above 85°C.

When the chip tantalum capacitor is used at 85°C or more temperatures, the reduced voltage ( $U_T$ ) is calculated from the following expression, however, note that the ambient temperature is not more than 125°C.

$$U_T = V_0 (U_R - U_C)(T - 85) / 40$$

$U_R$ : Rated voltage (V);  $U_C$ : Derating voltage at 125°C; T: Ambient temperature (°C )

#### 4) Protective Resistance

In a circuit (switching circuit, charge / discharge circuit, etc.) that has an instantaneous current, series resistance is at least  $3\Omega/V$ , this can improve the reliability of tantalum capacitors. If the capacitor is in a low impedance circuit, the voltage applied to the capacitor should be half or one third of the rated voltage.

#### 5) Redundancy

MnO<sub>2</sub> tantalum capacitors will heat, and may cause fire and burn in the short circuit. This is determined by the situation, time and other factors. When the circuit is designed, it is possible to provide the best possible space to keep the tantalum capacitor reliability.

#### 6) Test Condition

Ambient Temperature 25°C; Relative Humidity 60 to 70%; Air Pressure 800 to 1060mbar. Test and experiment, in order to make the test results not problems, it is necessary to will test the product after fully discharge.

This product is a polar components, testing or when using it is strictly prohibited to will is negative pick back, in order to avoid performance failure

#### 7) Soldering

The SMD tantalum capacitor can be used for reflow soldering, which is not suitable for wave soldering and manual welding. The reflow temperature are  $\leq 250^{\circ}\text{C}$ ,  $\leq 5$  seconds. If you must use manual welding, should use the melted solder to contact lead, and the electric soldering iron power should be less than or equal to 25W, temperature should be less than  $300^{\circ}\text{C}$ , welding time should be less than 3 seconds, can not use electric iron contact the product lead directly, and in particular, can not contact the product ontology directly. Recommended profile conditions for convection and IR reflow reflect the profile conditions of the IPC/J-STD-020D standard for moisture sensitivity testing

RECOMMENDED PROFILE CONDITIONS –Only For reference

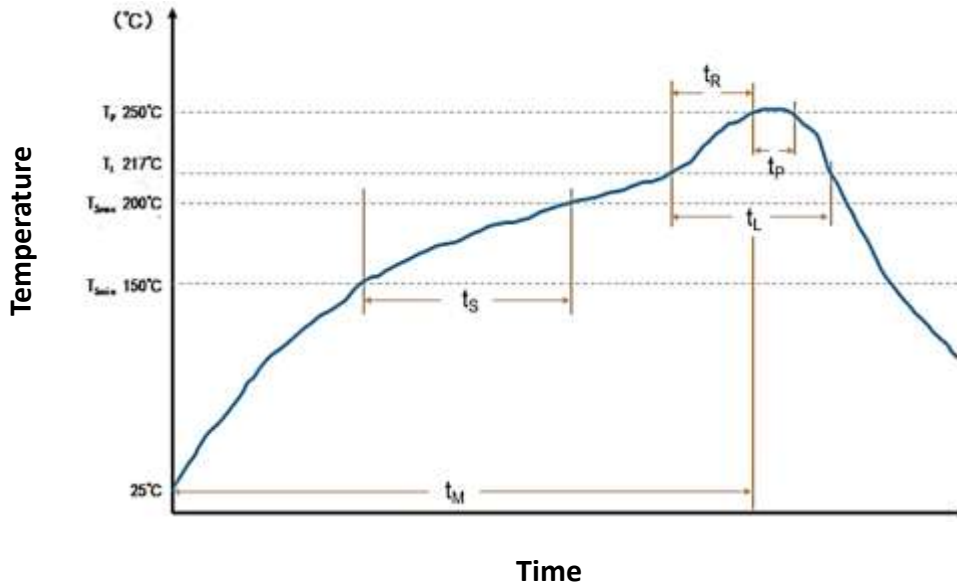

CHARACTERISTICS	UNIT	SYMBOL	SnPb ASSEMBLY	Pb-Free ASSEMBLY
Preheat Temperature Min.	°C	T smin	100	150
Preheat Temperature Max.	°C	T smax	150	200
Preheat time	Second	T s	60~120	60~120
Ramp-up Rate	°C/Second	T L to T p	≤ 3	≤ 3
Liquidous Temperature	°C	T L	183	217
Time Above Liquidous	Second	t L	60~150	60~150
Peak Temperature	°C	T p	220 or 235	245 or 250
Time within 5°C Max. Peak Temperature	Second	t p	≤ 10	≤ 3
Ramp-down Rate	°C/Second	T p to T L	≤ 6	≤ 6
Time 25°C to Peak Temperature	minute		≤ 6	≤ 6

RECOMMENDED VOLTAGE DERATING GUIDELINES – Only For reference

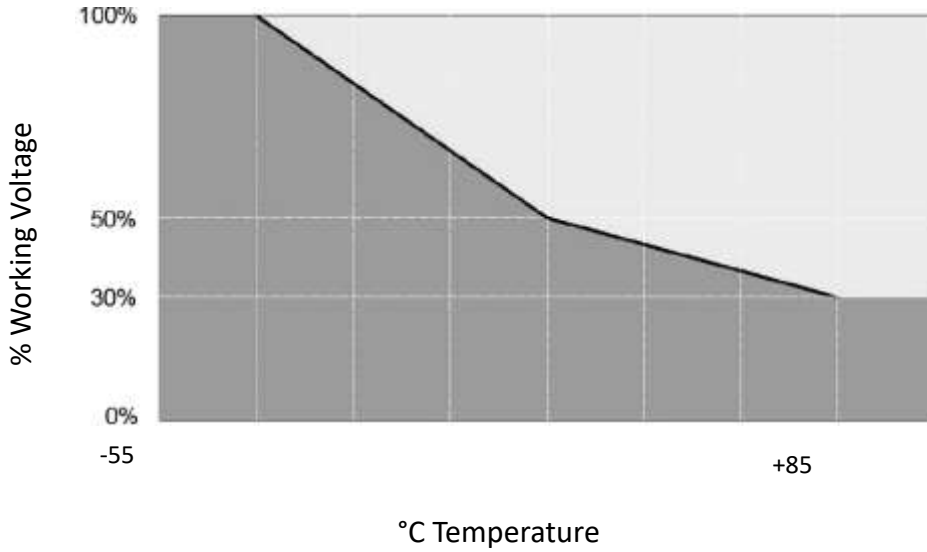

CONDITION	-55 °C ~ 85 °C
% Change in Working DC Voltage with Temperature	V <sub>R</sub>
Recommended Max. Application @V <sub>R</sub> ≤10V	50 of V <sub>R</sub>
Recommended Max. Application @V <sub>R</sub> ≥16V	30% of V <sub>R</sub>

TAPE DIMENSION (Unit: mm) Tolerance  $\pm 0.2$ mm over 10 sprocket hole spaces

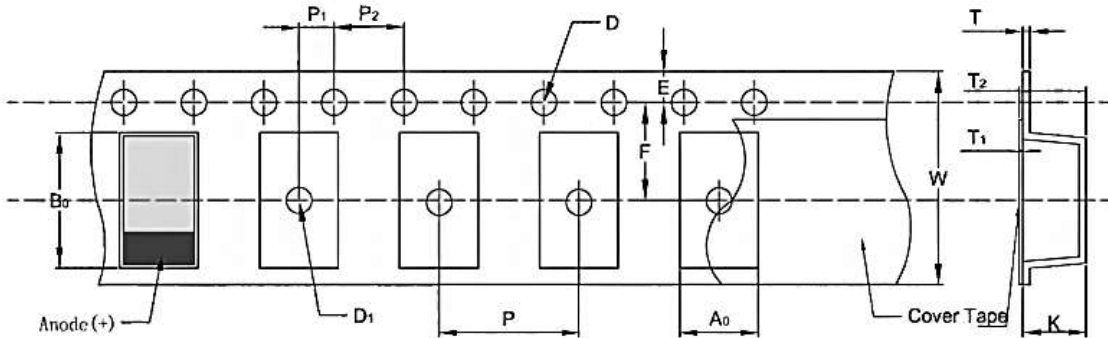

CASE SIZE CODE	DIMENSION										
	A0	B0	K	W	E	F	P2	P	P1	D	D1
	$\pm 0.1$	$\pm 0.1$	$\pm 0.1$	$\pm 0.3$	$\pm 0.1$	$\pm 0.05$	$\pm 0.1$	$\pm 0.05$	$\pm 0.1$	+0.2	+0.25
A	1.88	3.53	1.90	8.00	1.75	3.50	4.00	4.00	2.00	1.55	1.00
B1	3.07	3.80	2.22	8.00	1.75	3.50	4.00	4.00	2.00	1.55	1.10
B	3.07	3.80	2.22	8.00	1.75	3.50	4.00	4.00	2.00	1.55	1.10
C	3.60	6.40	2.85	12.00	1.75	5.50	4.00	8.00	2.00	1.55	1.60
H1	4.60	7.60	2.16	12.00	1.75	5.50	4.00	8.00	2.00	1.55	1.55
L	4.60	7.60	2.16	12.00	1.75	5.50	4.00	8.00	2.00	1.55	1.55
H	4.60	7.60	2.16	12.00	1.75	5.50	4.00	8.00	2.00	1.55	1.55
F	6.50	7.80	2.20	12.00	1.75	5.50	4.00	8.00	2.00	1.55	1.50
D	4.60	7.60	3.10	12.00	1.75	5.50	4.00	8.00	2.00	1.55	1.55
Y	4.60	7.60	3.10	12.00	1.75	5.50	4.00	8.00	2.00	1.55	1.55
E	4.60	7.60	4.40	12.00	1.75	5.50	4.00	8.00	2.00	1.55	1.55
V	6.40	7.60	4.40	12.00	1.75	5.50	4.00	8.00	2.00	1.55	1.55
W	6.50	8.00	4.70	16.00	1.75	7.50	4.00	12.00	2.00	1.55	1.55

REEL DIMENSION (Unit: mm)

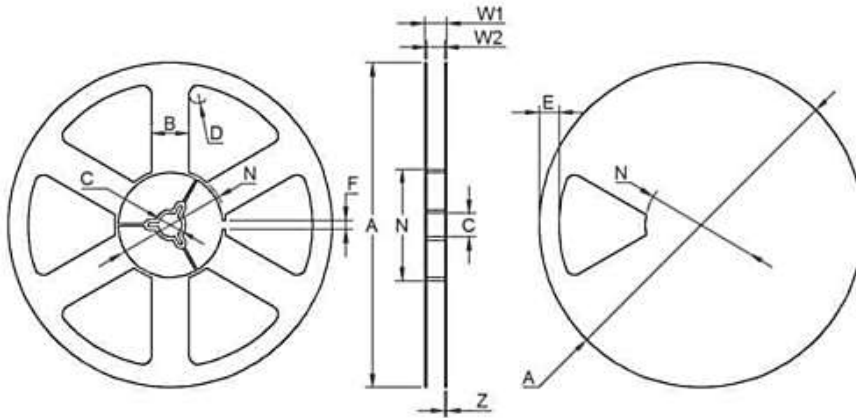

REEL SIZE	TAPE WIDE	DIMENSION				
		A	B	C	W2	W1
7" (180 mm)	8	178±2.0	50 Min.	13.2±0.5	8.4+1.5/-0	10.8+1.5/-0
7" (180 mm)	12	178±2.0	50 Min.	13.2±0.5	12.4+1.5/0	14.8+1.5/-0
7" (180 mm)	16	178±2.0	50 Min.	13.2±0.5	16.0+1.5/-0	19.0+1.5/-0
13" (330 mm)	12	330±2.0	50 Min.	13.2±0.5	12.4+1.5/-0	16.5+1.5/-0

QTY PER REEL (Unit: pcs)

CASE SIZE CODE	A	B1	B	C	H1	L	H	F	D	Y	E	V	W
Qty.	2000	2000	2000	500	1000	1000	1000	1000	500	500	500	400	400

## IMPORTANT NOTES AND DISCLAIMER

1. **ROHS COMPLIANCE:** The levels of RoHS restricted materials in this product are below the maximum concentration values (also referred to as the threshold limits) permitted for such substances, or are used in an exempted application, in accordance with EU RoHS Directive (EU) 2015/863 EC (RoHS3). RoHS Test Report for this product can be obtained at Download Center.
2. **REACH COMPLIANCE:** REACH substances of high concern (SVHCs) information is available for this product. Since the European Chemical Agency (ECHA) has published notice of their intent to frequently revise the SVHC listing for the foreseeable future, REACH Test Report for this product can be obtained at Download Center.
3. All Product parametric performance is indicated in the Electrical Characteristics for the listed herein test conditions, unless otherwise noted. Product performance may not be indicated by the Electrical Characteristics if operated under different conditions.
4. NextGen Component, Inc (*NextGen*) reserves the right to make changes to this document and its products and specifications at any time without notice. Customers should obtain and confirm the latest product information and specifications before final design, purchase or use.
5. *NextGen* makes no warranty, representation or guarantee regarding the suitability of its products for any particular purpose, not does *NextGen* assume any liability for application assistance or customer product design.
6. *NextGen* does not warrant or accept any liability with products which are purchased or used for any unintended or unauthorized application. No license is granted by implication or otherwise under any intellectual property rights of NextGen.
7. *NextGen* products are not authorized for use as critical components in life support devices or systems without express written approval by *NextGen*.
8. *NextGen* requires that customers first obtain an RMA (Returned Merchandise Authorization) number prior to returning any products. Returns must be made within 30 days of the date of invoice, be in the original packaging, unused and like-new condition. At the time of quoting or purchasing, a product may say that it is Non-Cancelable/ Non-Returnable (NCNR). These products are not returnable and not refundable.