



SPECIFICATION SHEET NO.	T0104- CA45C025K336TA	
ORIGINAL MFG/PART NO	XiangJiang/CA45-C-25V33/CA45-C025K336T/CA45-C025K336T-E0K7	
NEXTGEN PART CODE	CA45C025K336TA	Indicate This Code For <a href="#">RFQ</a> /Order
DATE	Jan. 4, 2026	
REVISION	A9	Updated With Most Recent Data
DESCRIPTION AND MAIN PARAMETRICS	<p>SMD Standard Tantalum Capacitors Industrial Grade MnO<sub>2</sub>, CA45 Series</p> <p>EIA code 6032-15 (2313) , Case C, L6.0*W3.2*H2.5mm</p> <p>Rated voltage 25 Vdc, Capacitance 33μF, Tolerance ±10%,</p> <p>ESR 0.7Ω Max. Operating Temp. Range -55°C ~+125°C</p> <p>Package in Tape/Reel, 500pcs/Reel</p> <p>RoHS/RoHS III compliant, RoHS Annex III lead Exemption (Exempt per RoHS EU 2015/863) and Halogen Free (HF)</p>	
CUSTOMER		
CUSTOMER PART NUMBER		
CROSS REF. PART NUMBER	T489/T490/T491/T493/TAJ/F93/TLJ/293D	
MEMO		

<b>VENDOR APPROVE</b>		
Issued/Checked/Approved		 
Effective Date: Jan. 4, 2026		

<b>CUSTOMER APPROVE</b>	
DATE:	

## MAIN FEATURE

- Epoxy Molded Encapsulation, Chip, Small In Size, Light In Weight
- Easy For Integration, Heteroploidy
- Lower ESR Than The Standard Chip Tantalum Capacitor
- Stable In Electrical & Storage Performances, Long Life-span
- Executive Technical Standards: QJ/PWV305-2008
- Wide Operating Temperature Range -55 ~ +125°C
- Cross Most Competitors Parts T489/T490/T491/T493/TAJ/F93/TLJ/293D and more
- Moisture Sensitivity Level (MSL) 1 (Unlimited)
- RoHS/RoHS III compliant, RoHS Annex III lead Exemption (Exempt per RoHS EU 2015/863) and Halogen Free (HF)



*Image shown is a representation only.  
Exact specifications should be  
obtained from the product dimension.*



## MAIN APPLICATION

- DC/DC Converters
- Portable Electronics
- Telecommunications And Control Units

## ELECTRICAL CHARACTERISTICS

- See Page 17 ~ Page 46 for Different Part Code
- All Products Parameters are Subject To NextGen Components' Final Confirmation.

**HOW TO ORDER**

- Please Follow Up Part Code Guide And Indicate NextGen Part Code CA45C025K336TA For RFQ and Order.

**PART CODE GUIDE**

**RFQ**  
[Request For Quotation](#)

CODE	NAME	KEY SPECIFICATION OPTION
CA45	Product Series Code	SMD Low ESR Chip Tantalum Capacitors Industrial Grade MnO <sub>2</sub>
C	Case Size Code	A: 3216-16 (1206) L3.2*W1.6*H1.6mm; B: 3528-19 (1210) L3.5*W2.8*H1.9mm C: 6032-15 (2313) L6.0*W3.2*H2.5mm; D: 7343-28 (2917) L7.3*W4.3*H2.8mm E: 7343-43 (2917) L7.3*W4.3*H4.3mm; G: 8R7R-4R (3430) L8.5*W7.5*H4.5mm P:2012-12 (0805)L2.0*W1.25*H1.2mm;T: 1112R-55 (4450) L11*W12.5*H5.5mm V: 7361-36 (2924)L7.3*W6.1*H3.6mm; W: 7361-41 (2924) L7.3*W6.1*H4.1mm
025	Rated voltage Code	2R5: 2.5V; 004: 4V; 6R3: 6.3V; 010: 10V; 016: 16V; 020: 20V; 025: 25V; 035: 35V; 050: 50V 063: 63V 075: 75V 100: 100V
K	Capacitance Tolerance code	K: ±10% (Standard); M: ±20%
336	Capacitance Code	1st two digits represent Significant figures, 3rd Digit specifies number of Zeros 474: 0.47µF; 684:0.68µF; 105: 1.0µF; 155: 1.5µF; 225: 2.2µF; 335: 3.3µF; 475: 4.7µF; 685: 6.8µF; 106: 10µF; 156: 15µF; 226: 22µF; 336: 33µF; 476: 47µF; 686: 68µF; 107: 100µF; 157: 150µF; 227: 220µF; 337: 330µF; 477: 470µF; 687: 680µF; 108: 1000µF; 158: 1500µF; 228: 2200µF
TA	Internal Control Code	Letter A~Z, a~z Or Digits (0-9)
XX	Special/ Custom Parameters	Blank: N/A; XX: Letter A~Z, a~z or digits (0~9) for Special/Custom Parameters

DIMENSIONS - - Unit: mm

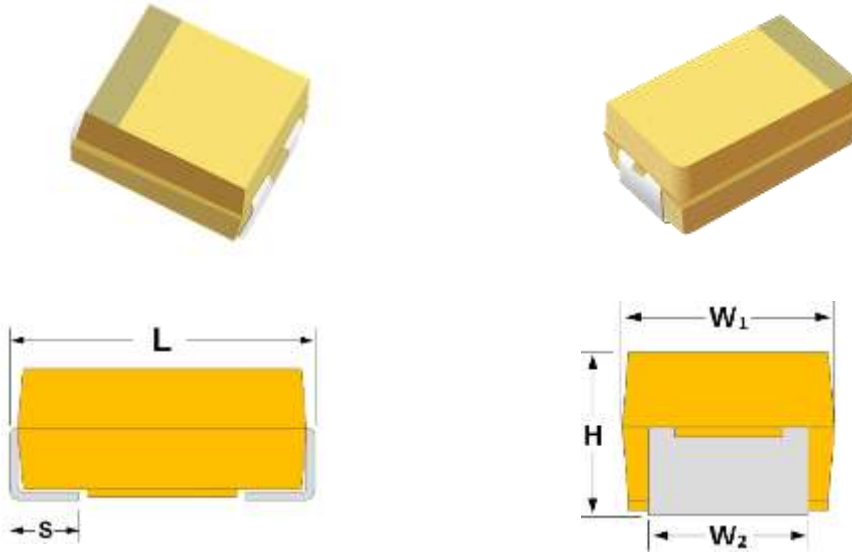

CASE SIZE CODE	EIA CODE	EIA METRIC	L	W <sub>1</sub>	H	S	W <sub>2</sub>
A	1206	3216-16	3.20±0.20	1.60±0.20	1.60±0.30	0.70±0.20	1.20±0.20
B	1210	3528-19	3.50±0.20	2.80±0.20	1.90±0.30	0.70±0.20	2.20±0.20
C	2312	6032-25	6.00±0.30	3.20±0.30	2.50±0.30	1.30±0.30	2.20±0.20
D	2917	7343-28	7.30±0.30	4.30±0.30	2.80±0.30	1.30±0.30	2.40±0.20
E	2917	7343-43	7.30±0.30	4.30±0.30	4.3±0.30	1.30±0.30	2.40±0.20
G	3430	8R7R-4R	8.50±0.30	7.50±0.30	4.50±0.30	1.80±0.30	4.50±0.20
P	0805	2012-12	2.00±0.20	1.25±0.20	1.20±0.20	0.50±0.10	0.90±0.10
T	4450	1112R-55	11.0±0.30	12.5±0.30	5.50±0.30	2.10±0.30	10.5±0.20
V	2924	7361-36	7.30±0.30	6.10±0.30	3.60±0.30	1.50±0.30	3.00±0.20
W	2924	7361-41	7.30±0.30	6.10±0.30	4.10±0.30	1.50±0.30	3.00±0.20

## LAND DIMENSIONS

Density Level A: For low-density product applications. Recommended for wave solder applications and provides a wider process window for reflow solder processes.

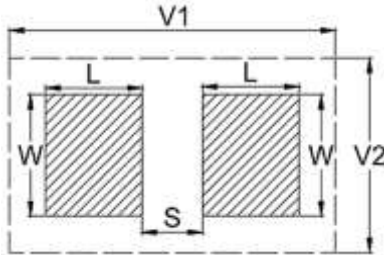

Note:

- Height of these chips may create problems in wave soldering.
- Land pattern geometry is too small for silkscreen outline.

CASE CODE	EIA METRIC	DIMENSION (MM)				
		W	L	S	V1	V2
A	3216-16	1.35	2.20	0.62	6.02	2.80
B1	3528-12	2.35	2.21	0.92	6.32	4.00
B	3528-19	2.35	2.21	0.92	6.32	4.00
C	6032-25	2.35	2.77	2.37	8.92	4.50
H1	7343-15	2.55	2.77	3.67	10.22	5.60
L	7343-19	2.55	2.77	3.67	10.22	5.60
H	7343-21	2.55	2.77	3.67	10.22	5.60
D	7343-28	2.55	2.77	3.67	10.22	5.60
Y	7343-40	2.55	2.77	3.67	10.22	5.60
E	7343-43	2.55	2.77	3.67	10.22	5.60
F	7361-19	3.25	2.77	3.67	10.22	7.30
V	7361-36	3.25	2.77	3.67	10.22	7.30
W	7361-41	3.25	2.77	3.67	10.22	7.30

**LAND DIMENSIONS**

Density Level B: For products with a moderate level of component density. Provides Recommended Profile

Conditions for reflow solder processes.

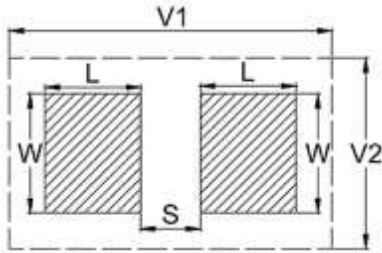

**Note:**

- Height of these chips may create problems in wave soldering.
- Land pattern geometry is too small for silkscreen outline.

CASE CODE	EIA METRIC	DIMENSION (MM)				
		W	L	S	V1	V2
A	3216-16	1.23	1.80	0.82	4.92	2.30
B1	3528-12	2.23	1.80	1.12	5.22	3.50
B	3528-19	2.23	1.80	1.12	5.22	3.50
C	6032-25	2.23	2.37	2.57	7.82	4.00
H1	7343-15	2.43	2.37	3.87	9.12	5.10
L	7343-19	2.43	2.37	3.87	9.12	5.10
H	7343-21	2.43	2.37	3.87	9.12	5.10
D	7343-28	2.43	2.37	3.87	9.12	5.10
Y	7343-40	2.43	2.37	3.87	9.12	5.10
E	7343-43	2.43	2.37	3.87	9.12	5.10
F	7361-19	3.13	2.37	3.87	9.12	6.80
V	7361-36	3.13	2.37	3.87	9.12	6.80
W	7361-41	3.13	2.37	3.87	9.12	6.80

## LAND DIMENSIONS

Density Level C: For high component density product applications. Before adapting the Min. land pattern variations, the user should perform qualification testing based on the conditions outlined in IPC - 7351).

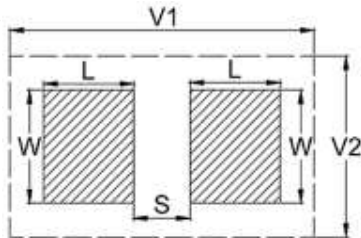

**Note:**

- Height of these chips may create problems in wave soldering.
- Land pattern geometry is too small for silkscreen outline.

CASE CODE	EIA METRIC	DIMENSION (MM)				
		W	L	S	V1	V2
A	3216-16	1.13	1.42	0.98	4.06	2.04
B1	3528-12	2.13	1.42	1.28	4.36	3.24
B	3528-19	2.13	1.42	1.28	4.36	3.24
C	6032-25	2.13	1.99	2.73	6.96	3.74
H1	7343-15	2.33	1.99	4.03	8.26	4.84
L	7343-19	2.33	1.99	4.03	8.26	4.84
H	7343-21	2.33	1.99	4.03	8.26	4.84
D	7343-28	2.33	1.99	4.03	8.26	4.84
Y	7343-40	2.33	1.99	4.03	8.26	4.84
E	7343-43	2.33	1.99	4.03	8.26	4.84
F	7361-19	3.03	1.99	4.03	8.26	6.54
V	7361-36	3.03	1.99	4.03	8.26	6.54
W	7361-41	3.03	1.99	4.03	8.26	6.54

**MARKING**

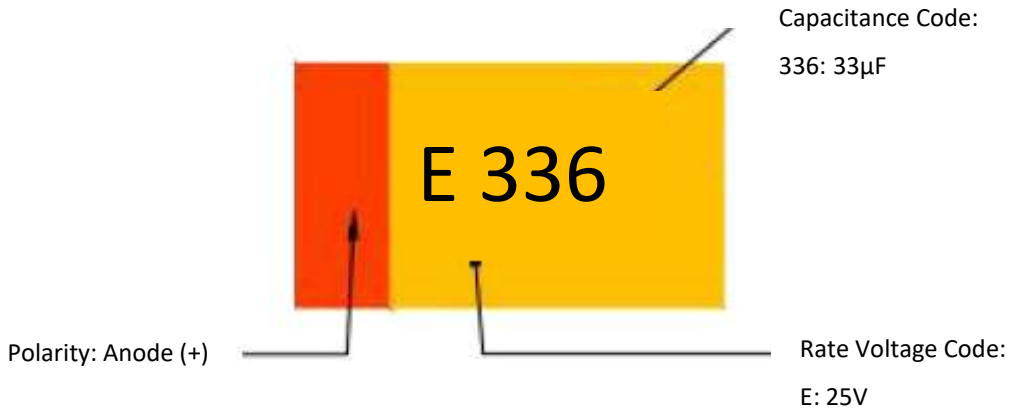

Voltage Code	F	G	J	A	C	D	E	V	H	T	63V	75V	100V
Rate Voltage (V)	2.5	4.0	6.3	10	16	20	25	35	40	50	63	75	100

**MAXIMUM OPERATING AND SURGE VOLTAGES VS. TEMPERATURE**

Rate Voltage (V <sub>R</sub> )	≤ 85°C	2.5	4.0	6.3	10	16	20	25
Category Voltage (V <sub>C</sub> )	≤ 125°C	1.7	2.7	4.2	6.7	10.7	13.3	16.7
Surge Voltage (V <sub>S</sub> )	≤ 85°C	2.9	4.6	7.2	11.5	18.4	23.0	28.8
Surge Voltage (V <sub>S</sub> )	≤ 125°C	1.9	3.1	4.8	7.7	12.3	15.3	19.2

Rate Voltage (V <sub>R</sub> )	≤ 85°C	35	40	50	63	75	100
Category Voltage (V <sub>C</sub> )	≤ 125°C	23.3	26.7	33.3	42	50	66.7
Surge Voltage (V <sub>S</sub> )	≤ 85°C	40.3	46.0	57.5	72.5	86.3	115
Surge Voltage (V <sub>S</sub> )	≤ 125°C	26.8	30.7	38.3	48.3	57.5	76.7



### BASIC INFORMATION

ITEM	CHARACTERISTIC
Dielectric	Ta2O5
Electrolyte	MnO2
Package Method	Epoxy Resin Molding (Semi-Seal)
Case Color	Yellow (std.) or Black
MSL	1
Termination Finish	Standard Solder-coated, Gold-plated Option

### STANDARD CHARACTERISTICS

PART CODE	CA45C025K336TA
Case Size Code	C
Case Dimension	L6.00*W3.20*H2.50mm
EIA Code	6032-15 (2313)
Capacitance Tolerance	±10%
Rate Temperature Range	85 °C
Category Voltage	16.7V
Category Temperature Range	125 °C
Operating Temperature Range	-55~ + 125 °C

CASE CODE, RATED VOLTAGE, CAPACITANCE AND ESR LIST

VOLTAGE CODE		F	G	J
Voltage (V)		2.5	4	6.3
Cap. Code	Cap.(µf)	Case Code (ESR mΩ)		
155	1.5			A(3000)
225	2.2		A(7600)	A(9000)
335	3.3		A(8000)	A(7000) B (5500)
475	4.7		A(8000) B (7000)	A (6000) B (4400)
685	6.8		A (6000) B (3400)	A (6000) B (5000)
106	10		A (6000) B (3500)	A (4000) B (3500) C (3000)
156	15		A (4000) B (3500) C (2800)	A (3500) B (3000) C (1800)
226	22		A (3500) B (3000) C (1800)	A (3000) B (2500) C (2000) D (2000)
336	33	A (1700)	A (3000) B (2800) C(1800) D(2200)	A (2500) B (2200) C (1800) D (1600)
476	47	A (3000)	A (2600) B (2400) C (1800) D (1600)	A (3500) B (2000) C (1600) D (1100) E (1100)
686	68	A (1500)	A (4000) B (1900) C (1500) D (1100)	A (4000) B (1800) C (1500) E (900)

CASE CODE, RATED VOLTAGE, CAPACITANCE AND ESR LIST

VOLTAGE CODE		F	G	J
Voltage (V)		2.5	4	6.3
Cap. Code	Cap.(µf)	Case Code (ESR mΩ)		
107	100	A (1400) B (1400)	A (4000) B (1800) C (1300) D (900)	A (3000) B (2000) C (900) D (800) E (800)
157	150	B (1600)	B (2000) C (1200) D (800) E (500) V (500)	B (3000) C (1300) D (900) E (700)
227	220	B (1600) D (300)	B (1500) C (1200) D (900) E (500)	B (1600) C (1200) D (700) E (500) V (500)
337	330	D (300)	C (900) D (900) E (800) V(600)	C (1200) D (600) E (500) V (300)
477	470	C (200) D (200)	C (300) D (900) E (500) V (300)	D (500) E (1500) V (400)
687	680	C (200) D (200) E (200)	D (500) E (900) V (300) W (350)	E (600) V (500) W (500)
108	1000	D (200) E (400)	D (200) E (500) V (200) W (200)	E (600) V (300) W (300)
158	1500	D (200) E (200) V (200)	E (200) V (200)	
228	2200	V (400)		

CASE CODE, RATED VOLTAGE, CAPACITANCE AND ESR LIST

VOLTAGE CODE		A	C	D
Voltage (V)		10	16	20
Cap. Code	Cap.(µf)	Case Code (ESR mΩ)		
474	0.47			A (14000)
684	0.68		A (12000)	A (12000)
105	1	A (10000) B (5000)	A (11000) B (5000) C (5000)	A (9000) B (9000)
155	1.5	A (10000) B (10000)	A (8000) B (6400)	A (6500) B (5600)
225	2.2	A (7000) B (4600)	A (6500) B (4600) C(4600)	A (6000) B (3500)
335	3.3	A (5500) B (5500)	A (5000) B (4500)	A (5900) B (3000) C (2300) D (2300)
475	4.7	A (5000) B (4000)	A (5000) B (3500) C (2900)	A (5000) B (3000) C (2800)
685	6.8	A (4200) B (3500) C (1900)	A (4200) B (2500) C (2500)	A (6000) B (2500) C (2000) D (1400)
106	10	A (3800) B (3000) C (2500) D (2500)	A (3000) B (2800) C (2000) D (2000) E (2000)	A (5000) B (2100) C (1700) D (1200) E (1200)
156	15	A (6000) B (2800) C (2000)	A (3500) B (2500) C (1800) D (1800)	B (2300) C (1700) D (1100)
226	22	A (3200) B (2400) C (1800) D (1600) E (1600)	A (2300) B (2300) C (1500) D (1000) E (1000)	B (4000) C (1600) D (900) E (900)

CASE CODE, RATED VOLTAGE, CAPACITANCE AND ESR LIST

VOLTAGE CODE		A	C	D
Voltage (V)		10	16	20
Cap. Code	Cap.(µf)	Case Code (ESR mΩ)		
336	33	A (6000) B (1900) C (1600) D (1100)	B (2100) C (1500) D (900) E (900)	B (4000) C (1500) D (900) E (700)
476	47	A (3000) B (1800) C (1200) D (900) E (900)	B (2500) C (1000) D (900) E (800) V (800)	C (900) D (900) E (900)
686	68	A (900) B (1800) C (1300) D (900) E (500)	B (800) C (1300) D (900) E (800)	C (500) D (700) E (900) V (600)
107	100	A (4000) B (2500) C (1200) D (900) E (800)	C (1000) D (700) E (900)	D (900) E (500) V (500)
157	150	C (900) D (900) E (900) V (500)	D (900) E (500) V (400)	D (500) E (400) V (400)
227	220	C (900) D (600) E (500) V (300)	D (900) E (500) V (900)	E (600) V (500) W (500)
337	330	D (900) E (900) V (500)	E (400) V (800) W (800)	E (800) V (800) W(800)
477	470	E (500) V (500)	E (400) W (400)	
687	680	E (400) W(400)		

CASE CODE, RATED VOLTAGE, CAPACITANCE AND ESR LIST

VOLTAGE CODE		E	V	H	T
Voltage (V)		25	35	40	50
Cap. Code	Cap.(µf)	Case Code (ESR mΩ)			
474	0.47	A (14000)	A(12000) B(10000)	A(9000) B(9000)	A(12000) B(9500) C(8000)
684	0.68	A(10000) B(6000)	A(8000) B(8000)	B(6000) C(7500)	A(8000) B(8000) C(7000)
105	1	A(8000) B(5000) C(5000)	A(7500) B(6500)	B(5000) C(6000)	A(7000) B(7000) C(5500) D(2200) E(2200)
155	1.5	A(7500) B(5000)	A(7500) B(5200) C(4500) D(4500)	B(4000) C(4500)	B(6000) C(4500) D(4000)
225	2.2	A(7000) B(4500) C(3500) D(3500)	A(4500) B(4200) C(3500) D(3500)	C(3000) D(2000)	B(4500) C(3000) D(2500) E(2000)
335	3.3	A(7000) B(3500) C(2800)	B(3500) C(2500) D(2500)	C(2000) D(2000)	C(2500) D(2000) E(1800)
475	4.7	A(6000) B(2800) C(2400) D(2400) E(1200)	B(3100) C(2200) D(1500) E(1200)	C(1500) D(1500) E(1500)	C(1500) D(1400) E(1200) V(1200)
685	6.8	B(2800) C(2000) D(1800) E(1800)	B(1800) C(1800) D(1300) E(900)	D(1200) E(1200)	C(1000) D(1000) E(900)
106	10	B(2500) C(1800) D(1200) E(900)	C(1600) D(1000) E(900)	D(900) E(900)	D(800) E(800) V(700)

CASE CODE, RATED VOLTAGE, CAPACITANCE AND ESR LIST

VOLTAGE CODE		E	V	H	T
Voltage (V)		25	35	40	50
Cap. Code	Cap.(μf)	Case Code (ESR mΩ)			
156	15	B(4000) C(1600) D(1000) E(1000)	C(1400) D(900) E(900)	E(700) V(900)	D(800) E(800) V(700)
226	22	B(1000) C(1400) D(900) E(700) V(700)	C(1400) D(900) E(700) V(500)	E(600) V(600) W(600)	E(600) W(400) V(400)
336	33	C(700) D(900) E(900)	D(900) E(900) W(500) V(500)	W(600)	E(900) W(600)
476	47	D(900) E(900) V(400)	D(900) E(900) V(500) W(600)		T(600)
686	68	D(900) E(900) V(500)	E(700) V(500) W(600)		
107	100	E (300) V (500)	G (600)		
157	150	E (600) V (400) W (400)			
227	220	W (500)			

CASE CODE, RATED VOLTAGE, CAPACITANCE AND ESR LIST

VOLTAGE CODE		63V	75V	100V
Voltage (V)		63	75	100
Cap. Code	Cap.(μf)	Case Code (ESR mΩ)		
474	0.47	C(7000)	C(7000)	C(6500)
684	0.68	C(6000)	C(6000)	C(5000) D(5000)
105	1	C(5000)	C(4500) D(4500)	D(4500)
155	1.5	D(3500)	D(3500)	
225	2.2	D(2000)	E(1800)	E(1500) V(1500)
335	3.3	D(1500)	E(1300)	
475	4.7	D(1000) E(1000)	E(900) V(900)	
685	6.8	D(900) E(900) V(900)		
106	10	D(900) E(900) V(900)		
156	15	E(900) V(900)		
226	22	D(900) E(900) W(900)		



ELECTRONICAL CHARACTERISTICS- RATED VOLTAGE 2.5V, CAPACITANCE TOL. ±10% (K)

Part Code	Rate Voltage ≤ 85°C	Cap. @25°C 100Hz	Max. Leakage Current @+25°C 5 min.	Max. Dissipation Factor (DF) @25°C 100Hz	ESR @25°C 100 KHz	Max. Ripple Current		
						@ 25°C 100KHz	@ 85°C 100KHz	@ 125°C 100KHz
	V	µF	µA	%	Ω	mA		
CA45A2R5K336TA	2.5	33	1	8	1.7	210	189	84
CA45A2R5K476TA	2.5	47	1	6	3	158	142	63
CA45A2R5K686TA	2.5	68	2	8	1.5	224	201	89
CA45A2R5K107TA	2.5	100	3	30	1.4	231	208	93
CA45B2R5K107TA	2.5	100	3	8	1.4	246	222	99
CA45B2R5K157TA	2.5	150	4	10	1.6	230	207	92
CA45B2R5K227TA	2.5	220	6	16	1.6	230	207	92
CA45D2R5K227TA	2.5	220	6	8	0.3	707	636	283
CA45D2R5K337TA	2.5	330	8	8	0.3	707	636	283
CA45C2R5K477TA	2.5	470	12	12	0.2	742	667	297
CA45D2R5K477TA	2.5	470	12	8	0.2	866	779	346
CA45C2R5K687TA	2.5	680	17	18	0.2	742	667	297
CA45D2R5K687TA	2.5	680	17	16	0.2	866	779	346
CA45E2R5K687TA	2.5	680	17	10	0.2	908	817	363
CA45D2R5K108TA	2.5	1000	25	20	0.2	866	779	346
CA45E2R5K108TA	2.5	1000	25	14	0.4	642	578	257
CA45D2R5K158TA	2.5	1500	38	60	0.2	866	779	346
CA45E2R5K158TA	2.5	1500	38	20	0.2	908	817	363
CA45V2R5K158TA	2.5	1500	38	20	0.2	1118	1006	447
CA45V2R5K228TA	2.5	2200	55	50	0.4	791	712	316

ELECTRONICAL CHARACTERISTICS- RATED VOLTAGE 4.0V, CAPACITANCE TOL. ±10% (K)

Part Code	Rate Voltage ≤ 85°C	Cap. @25°C 100Hz	Max. Leakage Current @+25°C 5 min.	Max. Dissipation Factor (DF) @25°C 100Hz	ESR @25°C 100 KHz	Max. Ripple Current		
						@ 25°C 100KHz	@ 85°C 100KHz	@ 125°C 100KHz
	V	µF	µA	%	Ω	mA		
CA45A004K225TA	4	2.2	1	6	7.6	99	89	40
CA45A004K335TA	4	3.3	1	6	8	97	87	39
CA45A004K475TA	4	4.7	1	6	8	97	87	39
CA45B004K475TA	4	4.7	1	6	7	110	99	44
CA45A004K685TA	4	6.8	1	6	6	112	101	45
CA45B004K685TA	4	6.8	1	6	3.4	158	142	63
CA45A004K106TA	4	10	1	6	6	112	101	45
CA45B004K106TA	4	10	1	6	3.5	156	140	62
CA45A004K156TA	4	15	1	6	4	137	123	55
CA45B004K156TA	4	15	1	6	3.5	156	140	62
CA45C004K156TA	4	15	1	6	2.8	198	178	79
CA45A004K226TA	4	22	1	6	3.5	146	132	59
CA45B004K226TA	4	22	1	6	3	168	151	67
CA45C004K226TA	4	22	1	6	1.8	247	222	99
CA45A004K336TA	4	33	1	6	3	158	142	63
CA45B004K336TA	4	33	1	6	2.8	174	157	70
CA45C004K336TA	4	33	1	6	1.8	247	222	99
CA45D004K336TA	4	33	1	6	2.2	261	235	104
CA45A004K476TA	4	47	2	14	2.6	170	153	68
CA45B004K476TA	4	47	2	6	2.4	188	169	75

ELECTRONICAL CHARACTERISTICS- RATED VOLTAGE 4.0V, CAPACITANCE TOL. ±10% (K)

Part Code	Rate Voltage ≤ 85°C	Cap. @25°C 100Hz	Max. Leakage Current @+25°C 5 min.	Max. Dissipation Factor (DF) @25°C 100Hz	ESR @25°C 100 KHz	Max. Ripple Current		
						@ 25°C 100KHz	@ 85°C 100KHz	@ 125°C 100KHz
	V	μF	μA	%	Ω	mA		
CA45C004K476TA	4	47	2	6	1.8	247	222	99
CA45D004K476TA	4	47	2	6	1.6	306	276	122
CA45A004K686TA	4	68	3	30	4	137	123	55
CA45B004K686TA	4	68	3	6	1.9	212	190	85
CA45C004K686TA	4	68	3	6	1.5	271	244	108
CA45D004K686TA	4	68	3	6	1.1	369	332	148
CA45A004K107TA	4	100	4	30	4	137	123	55
CA45B004K107TA	4	100	4	8	1.8	217	196	87
CA45C004K107TA	4	100	4	8	1.3	291	262	116
CA45D004K107TA	4	100	4	8	0.9	408	367	163
CA45B004K157TA	4	150	6	14	2	206	186	82
CA45C004K157TA	4	150	6	12	1.2	303	272	121
CA45D004K157TA	4	150	6	8	0.8	433	390	173
CA45E004K157TA	4	150	6	8	0.5	574	517	230
CA45V004K157TA	4	150	6	8	0.5	707	636	283
CA45B004K227TA	4	220	9	18	1.5	238	214	95
CA45C004K227TA	4	220	9	15	1.2	303	272	121
CA45D004K227TA	4	220	9	8	0.9	408	367	163
CA45E004K227TA	4	220	9	8	0.5	574	517	230
CA45C004K337TA	4	330	13	10	0.9	350	315	140

ELECTRONICAL CHARACTERISTICS- RATED VOLTAGE 4.0V, CAPACITANCE TOL. ±10% (K)

Part Code	Rate Voltage ≤ 85°C	Cap. @25°C 100Hz	Max. Leakage Current @+25°C 5 min.	Max. Dissipation Factor (DF) @25°C 100Hz	ESR @25°C 100 KHz	Max. Ripple Current		
						@ 25°C 100KHz	@ 85°C 100KHz	@ 125°C 100KHz
	V	µF	µA	%	Ω	mA		
CA45D004K337TA	4	330	13	8	0.9	408	367	163
CA45E004K337TA	4	330	13	8	0.8	454	409	182
CA45V004K337TA	4	330	13	10	0.6	645	581	258
CA45C004K477TA	4	470	19	14	0.3	606	545	242
CA45D004K477TA	4	470	19	12	0.9	408	367	163
CA45E004K477TA	4	470	19	10	0.5	574	517	230
CA45V004K477TA	4	470	19	12	0.3	913	822	365
CA45D004K687TA	4	680	27	25	0.5	548	493	219
CA45E004K687TA	4	680	27	14	0.9	428	385	171
CA45V004K687TA	4	680	27	12	0.3	913	822	365
CA45W004K687TA	4	680	27	12	0.35	845	761	338
CA45D004K108TA	4	1000	40	60	0.2	866	779	346
CA45E004K108TA	4	1000	40	20	0.5	574	517	230
CA45V004K108TA	4	1000	40	15	0.2	1118	1006	447
CA45W004K108TA	4	1000	40	16	0.2	1118	1006	447
CA45E004K158TA	4	1500	60	30	0.2	908	817	363
CA45V004K158TA	4	1500	60	30	0.2	1118	1006	447

ELECTRONICAL CHARACTERISTICS- RATED VOLTAGE 6.3V, CAPACITANCE TOL. ±10% (K)

Part Code	Rate Voltage ≤ 85°C	Cap. @25°C 100Hz	Max. Leakage Current @+25°C 5 min.	Max. Dissipation Factor (DF) @25°C 100Hz	ESR @25°C 100 KHz	Max. Ripple Current		
						@ 25°C 100KHz	@ 85°C 100KHz	@ 125°C 100KHz
	V	μF	μA	%	Ω	mA		
CA45A6R3K155TA	6.3	1.5	1	6	3	161	145	64
CA45A6R3K225TA	6.3	2.2	1	6	9	91	82	37
CA45A6R3K335TA	6.3	3.3	1	6	7	104	93	41
CA45B6R3K335TA	6.3	3.3	1	6	5.5	124	112	50
CA45A6R3K475TA	6.3	4.7	1	6	6	112	101	45
CA45B6R3K475TA	6.3	4.7	1	6	4.4	139	125	56
CA45A6R3K685TA	6.3	6.8	1	6	6	112	101	45
CA45B6R3K685TA	6.3	6.8	1	6	5	130	117	52
CA45A6R3K106TA	6.3	10	1	6	4	137	123	55
CA45B6R3K106TA	6.3	10	1	6	3.5	156	140	62
CA45C6R3K106TA	6.3	10	1	6	3	191	172	77
CA45P6R3K106TA	6.3	10	0.5	6	4	126	114	50
CA45A6R3K156TA	6.3	15	1	6	3.5	146	132	59
CA45B6R3K156TA	6.3	15	1	6	3	168	151	67
CA45C6R3K156TA	6.3	15	1	6	1.8	247	222	99
CA45A6R3K226TA	6.3	22	1	6	3	158	142	63
CA45B6R3K226TA	6.3	22	1	6	2.5	184	166	74
CA45C6R3K226TA	6.3	22	1	6	2	235	211	94
CA45D6R3K226TA	6.3	22	1	6	2	274	246	110
CA45A6R3K336TA	6.3	33	2	14	3	173	156	69

ELECTRONICAL CHARACTERISTICS- RATED VOLTAGE 6.3V, CAPACITANCE TOL. ±10% (K)

Part Code	Rate Voltage ≤ 85°C	Cap. @25°C 100Hz	Max. Leakage Current @+25°C 5 min.	Max. Dissipation Factor (DF) @25°C 100Hz	ESR @25°C 100 KHz	Max. Ripple Current		
						@ 25°C 100KHz	@ 85°C 100KHz	@ 125°C 100KHz
	V	µF	µA	%	Ω	mA		
CA45B6R3K336TA	6.3	33	2	6	2	197	177	79
CA45C6R3K336TA	6.3	33	2	6	2	247	222	99
CA45D6R3K336TA	6.3	33	2	6	1.6	306	276	122
CA45A6R3K476TA	6.3	47	3	12	4	146	132	59
CA45B6R3K476TA	6.3	47	3	6	2	206	186	82
CA45C6R3K476TA	6.3	47	3	6	1.6	262	236	105
CA45D6R3K476TA	6.3	47	3	6	1.1	369	332	148
CA45E6R3K476TA	6.3	47	3	6	1.1	387	349	155
CA45A6R3K686TA	6.3	68	4	30	4	137	123	55
CA45B6R3K686TA	6.3	68	4	8	2	217	196	87
CA45C6R3K686TA	6.3	68	4	6	2	271	244	108
CA45D6R3K686TA	6.3	68	4	6	1	408	367	163
CA45A6R3K107TA	6.3	100	6	26	3	158	142	63
CA45B6R3K107TA	6.3	100	6	15	2	206	186	82
CA45C6R3K107TA	6.3	100	6	8	1	350	315	140
CA45D6R3K107TA	6.3	100	6	8	1	433	390	173
CA45E6R3K107TA	6.3	100	6	8	1	454	409	182
CA45B6R3K157TA	6.3	150	10	15	3	168	151	67
CA45C6R3K157TA	6.3	150	10	8	1	291	262	116
CA45D6R3K157TA	6.3	150	10	8	1	408	367	163

ELECTRONICAL CHARACTERISTICS- RATED VOLTAGE 6.3V, CAPACITANCE TOL. ±10% (K)

Part Code	Rate Voltage ≤ 85°C	Cap. @25°C 100Hz	Max. Leakage Current @+25°C 5 min.	Max. Dissipation Factor (DF) @25°C 100Hz	ESR @25°C 100 KHz	Max. Ripple Current		
						@ 25°C 100KHz	@ 85°C 100KHz	@ 125°C 100KHz
	V	µF	µA	%	Ω	mA		
CA45E6R3K157TA	6.3	150	9	8	1	486	437	194
CA45B6R3K227TA	6.3	220	14	18	2	230	207	92
CA45C6R3K227TA	6.3	220	14	14	1	303	272	121
CA45D6R3K227TA	6.3	220	14	8	1	463	417	185
CA45E6R3K227TA	6.3	220	14	8	1	574	517	230
CA45V6R3K227TA	6.3	220	14	8	1	707	636	283
CA45C6R3K337TA	6.3	330	21	12	1	303	272	121
CA45D6R3K337TA	6.3	330	21	8	1	500	450	200
CA45E6R3K337TA	6.3	330	21	8	1	574	517	230
CA45V6R3K337TA	6.3	330	21	10	0	913	822	365
CA45D6R3K477TA	6.3	470	30	14	1	548	493	219
CA45E6R3K477TA	6.3	470	30	10	2	332	298	133
CA45V6R3K477TA	6.3	470	30	10	0	791	712	316
CA45E6R3K687TA	6.3	680	43	20	1	524	472	210
CA45V6R3K687TA	6.3	680	43	12	1	707	636	283
CA45W6R3K687TA	6.3	680	43	12	1	707	636	283
CA45E6R3K108TA	6.3	1000	63	30	1	524	472	210
CA45V6R3K108TA	6.3	1000	63	16	0	913	822	365
CA45W6R3K108TA	6.3	1000	63	16	0.3	913	822	365

ELECTRONICAL CHARACTERISTICS- RATED VOLTAGE 10V, CAPACITANCE TOL. ±10% (K)

Part Code	Rate Voltage ≤ 85°C	Cap. @25°C 100Hz	Max. Leakage Current @+25°C 5 min.	Max. Dissipation Factor (DF) @25°C 100Hz	ESR @25°C 100 KHz	Max. Ripple Current		
						@ 25°C 100KHz	@ 85°C 100KHz	@ 125°C 100KHz
	V	µF	µA	%	Ω	mA		
CA45A010K105TA	10	1	1	4	10	87	78	35
CA45B010K105TA	10	1	1	4	5	130	117	52
CA45A010K155TA	10	1.5	1	6	10	87	78	35
CA45B010K155TA	10	1.5	1	6	10	92	83	37
CA45A010K225TA	10	2.2	1	6	7	104	93	41
CA45B010K225TA	10	2.2	1	6	5	136	122	54
CA45A010K335TA	10	3.3	1	6	6	117	105	47
CA45B010K335TA	10	3.3	1	6	6	124	112	50
CA45A010K475TA	10	4.7	1	6	5	122	110	49
CA45B010K475TA	10	4.7	1	6	4	146	131	58
CA45P010K475TA	10	4.7	0.5	8	9	84	76	34
CA45A010K685TA	10	6.8	1	6	4	134	120	53
CA45B010K685TA	10	6.8	1	6	3.5	156	140	62
CA45C010K685TA	10	6.8	1	6	2	241	217	96
CA45A010K106TA	10	10	1	6	4	140	126	56
CA45B010K106TA	10	10	1	6	3	168	151	67
CA45C010K106TA	10	10	1	6	3	210	189	84
CA45D010K106TA	10	10	1	6	3	245	220	98
CA45P010K106TA	10	10	1	18	6.5	100	90	40
CA45A010K156TA	10	15	2	8	6	112	101	45



ELECTRONICAL CHARACTERISTICS- RATED VOLTAGE 10V, CAPACITANCE TOL. ±10% (K)

Part Code	Rate Voltage ≤ 85°C	Cap. @25°C 100Hz	Max. Leakage Current @+25°C 5 min.	Max. Dissipation Factor (DF) @25°C 100Hz	ESR @25°C 100 KHz	Max. Ripple Current		
						@ 25°C 100KHz	@ 85°C 100KHz	@ 125°C 100KHz
	V	µF	µA	%	Ω	mA		
CA45B010K156TA	10	15	2	6	2.8	174	157	70
CA45C010K156TA	10	15	2	6	2	235	211	94
CA45A010K226TA	10	22	2	8	3.2	153	138	61
CA45B010K226TA	10	22	2	6	2.4	188	169	75
CA45C010K226TA	10	22	2	6	1.8	247	222	99
CA45D010K226TA	10	22	2	6	1.6	306	276	122
CA45E010K226TA	10	22	2	6	1.6	321	289	128
CA45A010K336TA	10	33	3	15	6	112	101	45
CA45B010K336TA	10	33	3	6	1.9	212	190	85
CA45C010K336TA	10	33	3	6	1.6	262	236	105
CA45D010K336TA	10	33	3	6	1.1	369	332	148
CA45A010K476TA	10	47	5	26	3	158	142	63
CA45B010K476TA	10	47	5	8	1.8	217	196	87
CA45C010K476TA	10	47	5	6	1.2	303	272	121
CA45D010K476TA	10	47	5	6	0.9	408	367	163
CA45E010K476TA	10	47	5	6	0.9	428	385	171
CA45A010K686TA	10	68	7	6	0.9	173	156	69
CA45B010K686TA	10	68	7	14	1.8	217	196	87
CA45C010K686TA	10	68	7	6	1.3	291	262	116
CA45D010K686TA	10	68	7	6	0.9	408	367	163

ELECTRONICAL CHARACTERISTICS- RATED VOLTAGE 10V, CAPACITANCE TOL. ±10% (K)

Part Code	Rate Voltage ≤ 85°C	Cap. @25°C 100Hz	Max. Leakage Current @+25°C 5 min.	Max. Dissipation Factor (DF) @25°C 100Hz	ESR @25°C 100 KHz	Max. Ripple Current		
						@ 25°C 100KHz	@ 85°C 100KHz	@ 125°C 100KHz
	V	μF	μA	%	Ω	mA		
CA45E010K686TA	10	68	7	6	0.5	574	517	230
CA45A010K107TA	10	100	10	30	4	137	123	55
CA45B010K107TA	10	100	10	25	2.5	184	166	74
CA45C010K107TA	10	100	10	8	1.2	303	272	121
CA45D010K107TA	10	100	10	8	0.9	408	367	163
CA45E010K107TA	10	100	10	8	0.8	454	409	182
CA45C010K157TA	10	150	15	20	0.9	350	315	140
CA45D010K157TA	10	150	15	8	0.9	408	367	163
CA45E010K157TA	10	150	15	8	0.9	428	385	171
CA45V010K157TA	10	150	15	8	0.5	707	636	283
CA45C010K227TA	10	220	22	16	0.9	350	315	140
CA45D010K227TA	10	220	22	8	0.6	500	450	200
CA45E010K227TA	10	220	22	8	0.5	574	517	230
CA45V010K227TA	10	220	22	8	0.3	913	822	365
CA45C010K337TA	10	330	33	18	1.2	303	272	121
CA45D010K337TA	10	330	33	15	0.9	408	367	163
CA45E010K337TA	10	330	33	10	0.9	428	385	171
CA45V010K337TA	10	300	33	10	0.5	707	636	283
CA45D010K477TA	10	470	47	14	0.5	548	493	219
CA45E010K477TA	10	470	47	15	0.5	574	517	230



ELECTRONICAL CHARACTERISTICS- RATED VOLTAGE 16V, CAPACITANCE TOL. ±10% (K)

Part Code	Rate Voltage ≤ 85°C	Cap. @25°C 100Hz	Max. Leakage Current @+25°C 5 min.	Max. Dissipation Factor (DF) @25°C 100Hz	ESR @25°C 100 KHz	Max. Ripple Current		
						@ 25°C 100KHz	@ 85°C 100KHz	@ 125°C 100KHz
	V	µF	µA	%	Ω	mA		
CA45A016K684TA	16	0.68	1	4	12	79	71	32
CA45A016K105TA	16	1	1	4	11	83	74	33
CA45B016K105TA	16	1	1	4	5	130	117	52
CA45C016K105TA	16	1	1	4	5	148	133	59
CA45A016K155TA	16	1.5	1	6	8	97	87	39
CA45B016K155TA	16	1.5	1	6	6.4	115	104	46
CA45A016K225TA	16	2.2	1	6	6.5	107	97	43
CA45B016K225TA	16	2.2	1	6	4.6	136	122	54
CA45C016K225TA	16	2.2	1	6	4.6	155	139	62
CA45A016K335TA	16	3.3	1	6	5	122	110	49
CA45B016K335TA	16	3.3	1	6	4.5	137	124	55
CA45A016K475TA	16	4.7	1	6	5	122	110	49
CA45B016K475TA	16	4.7	1	6	3.5	156	140	62
CA45C016K475TA	16	4.7	1	6	2.9	195	175	78
CA45A016K685TA	16	6.8	1	6	4.2	134	120	53
CA45B016K685TA	16	6.8	1	6	2.5	184	166	74
CA45C016K685TA	16	6.8	1	6	2.5	210	189	84
CA45A016K106TA	16	10	2	6	3	158	142	63
CA45B016K106TA	16	10	2	6	2.8	174	157	70
CA45C016K106TA	16	10	2	6	2	235	211	94

**ELECTRONICAL CHARACTERISTICS- RATED VOLTAGE 16V, CAPACITANCE TOL. ±10% (K)**

Part Code	Rate Voltage ≤ 85°C	Cap. @25°C 100Hz	Max. Leakage Current @+25°C 5 min.	Max. Dissipation Factor (DF) @25°C 100Hz	ESR @25°C 100 KHz	Max. Ripple Current		
						@ 25°C 100KHz	@ 85°C 100KHz	@ 125°C 100KHz
	V	µF	µA	%	Ω	mA		
CA45D016K106TA	16	10	2	6	2	274	246	110
CA45E016K106TA	16	10	2	6	2	287	259	115
CA45A016K156TA	16	15	2	8	3.5	146	132	59
CA45B016K156TA	16	15	2	6	2.5	184	166	74
CA45C016K156TA	16	15	2	6	1.8	247	222	99
CA45D016K156TA	16	15	2	6	1.8	289	260	115
CA45A016K226TA	16	22	4	10	2.3	181	163	72
CA45B016K226TA	16	22	4	6	2.3	192	173	77
CA45C016K226TA	16	22	4	6	1.5	271	244	108
CA45D016K226TA	16	22	4	6	1	387	349	155
CA45E016K226TA	16	22	4	6	1	406	366	162
CA45B016K336TA	16	33	5	8	2.1	201	181	80
CA45C016K336TA	16	33	5	6	1.5	271	244	108
CA45D016K336TA	16	33	5	6	0.9	408	367	163
CA45E016K336TA	16	33	5	6	0.9	428	385	171
CA45B016K476TA	16	47	8	14	2.5	184	166	74
CA45C016K476TA	16	47	8	6	1	332	298	133
CA45D016K476TA	16	47	8	6	0.9	408	367	163
CA45E016K476TA	16	47	8	6	0.8	454	408	182
CA45V016K476TA	16	47	8	6	0.8	559	503	224

**ELECTRONICAL CHARACTERISTICS- RATED VOLTAGE 16V, CAPACITANCE TOL. ±10% (K)**

Part Code	Rate Voltage ≤ 85°C	Cap. @25°C 100Hz	Max. Leakage Current @+25°C 5 min.	Max. Dissipation Factor (DF) @25°C 100Hz	ESR @25°C 100 KHz	Max. Ripple Current		
						@ 25°C 100KHz	@ 85°C 100KHz	@ 125°C 100KHz
	V	µF	µA	%	Ω	mA		
CA45B016K686TA	16	68	11	6	0.8	326	293	130
CA45C016K686TA	16	68	11	6	1.3	291	262	116
CA45D016K686TA	16	68	11	6	0.9	408	367	163
CA45E016K686TA	16	68	11	6	0.8	454	409	182
CA45C016K107TA	16	100	16	10	1	332	298	133
CA45D016K107TA	16	100	16	8	0.7	463	417	185
CA45E016K107TA	16	100	16	8	0.9	428	385	171
CA45D016K157TA	16	150	24	10	0.9	408	367	163
CA45E016K157TA	16	150	24	8	0.5	574	517	230
CA45V016K157TA	16	150	24	8	0.4	791	712	316
CA45D016K227TA	16	220	35	15	0.9	408	367	163
CA45E016K227TA	16	220	35	14	0.5	574	517	230
CA45V016K227TA	16	220	35	7.2	0.9	527	474	211
CA45E016K337TA	16	330	53	30	0.4	642	578	257
CA45V016K337TA	16	330	53	12	0.8	559	503	224
CA45W016K337TA	16	330	53	10	0.8	559	503	224
CA45E016K447TA	16	470	75	16	0.4	642	578	257
CA45W016K447TA	16	470	75	16	0.4	791	712	316

ELECTRONICAL CHARACTERISTICS- RATED VOLTAGE 20V, CAPACITANCE TOL. ±10% (K)

Part Code	Rate Voltage ≤ 85°C	Cap. @25°C 100Hz	Max. Leakage Current @+25°C 5 min.	Max. Dissipation Factor (DF) @25°C 100Hz	ESR @25°C 100 KHz	Max. Ripple Current		
						@ 25°C 100KHz	@ 85°C 100KHz	@ 125°C 100KHz
	V	µF	µA	%	Ω	mA		
CA45A020K474TA	20	0.47	1	4	14	73	66	29
CA45A020K684TA	20	0.68	1	4	12	79	71	32
CA45A020K105TA	20	1	1	4	9	91	82	37
CA45B020K105TA	20	1	1	4	9	97	87	39
CA45A020K155TA	20	1.5	1	6	6.5	107	97	43
CA45B020K155TA	20	1.5	1	4.8	5.6	123	111	49
CA45A020K225TA	20	2.2	1	6	6	112	101	45
CA45B020K225TA	20	2.2	1	6	3.5	156	140	62
CA45A020K335TA	20	3.3	1	6	5.9	113	101	45
CA45B020K335TA	20	3.3	1	6	3	168	151	67
CA45C020K335TA	20	3.3	1	6	2.3	219	197	87
CA45D020K335TA	20	3.3	1	6	2.3	255	230	102
CA45A020K475TA	20	4.7	1	6	5	122	110	49
CA45B020K475TA	20	4.7	1	6	3	168	151	67
CA45C020K475TA	20	4.7	1	6	2.8	198	178	79
CA45D020K475TA	20	4.7	1	6	2.8	231	208	93
CA45A020K685TA	20	6.8	1	8	6	112	101	45
CA45B020K685TA	20	6.8	1	6	2.5	184	166	74
CA45C020K685TA	20	6.8	1	6	2	235	211	94
CA45D020K685TA	20	6.8	1	6	1.4	327	295	131

**ELECTRONICAL CHARACTERISTICS- RATED VOLTAGE 20V, CAPACITANCE TOL. ±10% (K)**

Part Code	Rate Voltage ≤ 85°C	Cap. @25°C 100Hz	Max. Leakage Current @+25°C 5 min.	Max. Dissipation Factor (DF) @25°C 100Hz	ESR @25°C 100 KHz	Max. Ripple Current		
						@ 25°C 100KHz	@ 85°C 100KHz	@ 125°C 100KHz
	V	µF	µA	%	Ω	mA		
CA45A020K106TA	20	10	2	10	5	122	110	49
CA45B020K106TA	20	10	2	6	2.1	201	181	80
CA45C020K106TA	20	10	2	6	1.7	254	229	102
CA45D020K106TA	20	10	2	6	1.2	354	318	141
CA45E020K106TA	20	10	2	6	1.2	371	334	148
CA45A020M106TA	20	10	2	10	5	122	110	49
CA45B020K156TA	20	15	3	6	2.3	192	173	77
CA45C020K156TA	20	15	3	6	1.7	254	229	102
CA45D020K156TA	20	15	3	6	1.1	369	332	148
CA45B020K226TA	20	22	4	8	4	146	131	58
CA45C020K226TA	20	22	4	6	1.6	262	236	105
CA45D020K226TA	20	22	4	6	0.9	408	367	163
CA45E020K226TA	20	22	4	6	0.9	428	385	171
CA45B020K336TA	20	33	7	10	4	146	131	58
CA45C020K336TA	20	33	7	6	1.5	271	244	108
CA45D020K336TA	20	33	7	6	0.9	408	367	163
CA45E020K336TA	20	33	7	6	0.7	486	437	194
CA45C020K476TA	20	47	9	6	0.9	350	315	140
CA45D020K476TA	20	47	9	6	0.9	408	367	163
CA45E020K476TA	20	47	9	6	0.9	428	385	171



**ELECTRONICAL CHARACTERISTICS- RATED VOLTAGE 20V, CAPACITANCE TOL. ±10% (K)**

Part Code	Rate Voltage ≤ 85°C	Cap. @25°C 100Hz	Max. Leakage Current @+25°C 5 min.	Max. Dissipation Factor (DF) @25°C 100Hz	ESR @25°C 100 KHz	Max. Ripple Current		
						@ 25°C 100KHz	@ 85°C 100KHz	@ 125°C 100KHz
	V	µF	µA	%	Ω	mA		
CA45C020K686TA	20	68	14	8	0.5	469	422	188
CA45D020K686TA	20	68	14	6	0.7	463	417	185
CA45E020K686TA	20	68	14	6	0.9	428	385	171
CA45V020K686TA	20	68	14	6	0.6	645	581	258
CA45D020K107TA	20	100	20	8	0.9	408	367	163
CA45E020K107TA	20	100	20	8	0.5	574	517	230
CA45V020K107TA	20	100	20	8	0.5	707	636	283
CA45D020K157TA	20	150	30	8	0.5	548	493	219
CA45E020K157TA	20	150	30	10	0.4	642	578	257
CA45V020K157TA	20	150	30	8	0.4	791	712	316
CA45E020K227TA	20	220	44	12	0.6	524	472	210
CA45V020K227TA	20	220	44	12	0.5	707	636	283
CA45W020K227TA	20	220	44	10	0.5	707	636	283
CA45E020K337TA	20	330	66	20	0.8	454	409	182
CA45V020K337TA	20	330	66	20	0.8	559	503	224
CA45W020K337TA	20	330	66	10	0.8	559	503	224

**ELECTRONICAL CHARACTERISTICS- RATED VOLTAGE 25V, CAPACITANCE TOL. ±10% (K)**

Part Code	Rate Voltage ≤ 85°C	Cap. @25°C 100Hz	Max. Leakage Current @+25°C 5 min.	Max. Dissipation Factor (DF) @25°C 100Hz	ESR @25°C 100 KHz	Max. Ripple Current		
						@ 25°C 100KHz	@ 85°C 100KHz	@ 125°C 100KHz
	V	µF	µA	%	Ω	mA		
CA45A025K474TA	25	0.47	1	4	14	73	66	29
CA45A025K684TA	25	0.68	1	4	10	87	78	35
CA45B025K684TA	25	0.68	1	4	6	119	107	48
CA45A025K105TA	25	1	1	4	8	97	87	39
CA45B025K105TA	25	1	1	4	5	130	117	52
CA45C025K105TA	25	1	1	4	5	148	133	59
CA45A025K155TA	25	1.5	1	6	7.5	100	90	40
CA45B025K155TA	25	1.5	1	6	5	130	117	52
CA45A025K225TA	25	2.2	1	6	7	104	93	41
CA45B025K225TA	25	2.2	1	6	4.5	137	124	55
CA45C025K225TA	25	2.2	1	6	3.5	177	160	71
CA45A025K335TA	25	3.3	1	6	7	104	93	41
CA45B025K335TA	25	3.3	1	6	3.5	156	140	62
CA45C025K335TA	25	3.3	1	6	2.8	198	178	79
CA45A025K475TA	25	4.7	1	8	6	112	101	45
CA45B025K475TA	25	4.7	1	6	2.8	174	157	70
CA45C025K475TA	25	4.7	1	6	2.4	214	193	86
CA45D025K475TA	25	4.7	1	6	2.4	250	225	100
CA45E025K475TA	25	4.7	1	6	1.2	371	334	148
CA45B025K685TA	25	6.8	2	6	2.8	174	157	70

ELECTRONICAL CHARACTERISTICS- RATED VOLTAGE 25V, CAPACITANCE TOL. ±10% (K)

Part Code	Rate Voltage ≤ 85°C	Cap. @25°C 100Hz	Max. Leakage Current @+25°C 5 min.	Max. Dissipation Factor (DF) @25°C 100Hz	ESR @25°C 100 KHz	Max. Ripple Current		
						@ 25°C 100KHz	@ 85°C 100KHz	@ 125°C 100KHz
	V	µF	µA	%	Ω	mA		
CA45C025K685TA	25	6.8	2	6	2	235	211	94
CA45D025K685TA	25	6.8	2	6	1.8	289	260	115
CA45E025K685TA	25	6.8	2	6	1.8	303	272	121
CA45B025K106TA	25	10	3	6	2.5	184	166	74
CA45C025K106TA	25	10	3	6	1.8	247	222	99
CA45D025K106TA	25	10	3	6	1.2	354	318	141
CA45E025K106TA	25	10	3	6	0.9	428	385	171
CA45B025K156TA	25	15	4	8	4	146	131	58
CA45C025K156TA	25	15	4	6	1.6	262	236	105
CA45D025K156TA	25	15	4	6	1	387	349	155
CA45E025K156TA	25	15	4	6	1	406	366	162
CA45B025K226TA	25	22	6	6	1	292	262	117
CA45C025K226TA	25	22	6	6	1.4	280	252	112
CA45D025K226TA	25	22	6	6	0.9	408	367	163
CA45E025K226TA	25	22	6	6	0.7	486	437	194
CA45V025K226TA	25	22	6	6	0.7	598	538	239
CA45C025K336TA	25	33	8	6	0.7	271	244	108
CA45D025K336TA	25	33	8	6	0.9	408	367	163
CA45E025K336TA	25	33	8	6	0.9	428	385	171
CA45D025K476TA	25	47	12	8	0.9	408	367	163

ELECTRONICAL CHARACTERISTICS- RATED VOLTAGE 25V, 30V, CAPACITANCE TOL. ±10% (K)

Part Code	Rate Voltage ≤ 85°C	Cap. @25°C 100Hz	Max. Leakage Current @+25°C 5 min.	Max. Dissipation Factor (DF) @25°C 100Hz	ESR @25°C 100 KHz	Max. Ripple Current		
						@ 25°C 100KHz	@ 85°C 100KHz	@ 125°C 100KHz
	V	µF	µA	%	Ω	mA		
CA45E025K476TA	25	47	12	6	0.9	428	385	171
CA45V025K476TA	25	47	12	6	0.4	791	712	316
CA45D025K686TA	25	68	17	10	0.9	408	367	163
CA45E025K686TA	25	68	17	8	0.9	428	385	171
CA45V025K686TA	25	68	17	6	0.5	707	636	283
CA45D025K107TA	25	100	25	10	0.7	486	437	194
CA45E025K107TA	25	100	25	10	0.3	742	667	297
CA45V025K107TA	25	100	25	8	0.5	707	636	283
CA45E025K157TA	25	150	3B	8	0.6	524	472	210
CA45V025K157TA	25	150	38	10	0.4	791	712	316
CA45W025K157TA	25	150	38	8	0.4	791	712	316
CA45G025K227TA	25	220	55	8	0.4	775	697	310
CA45E030K107TA	30	100	30	10	0.3	742	667	297
CA45W030K107TA	30	100	30	8	0.5	707	636	283

ELECTRONICAL CHARACTERISTICS- RATED VOLTAGE 35V, CAPACITANCE TOL. ±10% (K)

Part Code	Rate Voltage ≤ 85°C	Cap. @25°C 100Hz	Max. Leakage Current @+25°C 5 min.	Max. Dissipation Factor (DF) @25°C 100Hz	ESR @25°C 100 KHz	Max. Ripple Current		
						@ 25°C 100KHz	@ 85°C 100KHz	@ 125°C 100KHz
	V	µF	µA	%	Ω	mA		
CA45A035K104TA	35	0.1	0.5	6	10	177	159	71
CA45A035K224TA	35	0.22	0.5	4	15	71	64	28
CA45A035K334TA	35	0.33	0.5	4	10	87	78	35
CA45A035K474TA	35	0.47	1	4	12	79	71	32
CA45B035K474TA	35	0.47	1	A	10	92	83	37
CA45A035K684TA	35	0.68	1	4	8	97	87	39
CA45B035K684TA	35	0.68	1	4	8	103	93	41
CA45A035K105TA	35	1	1	4	7.5	100	90	40
CA45B035K105TA	35	1	1	4	6.5	114	103	46
CA45A035K155TA	35	1.5	1	6	7.5	100	90	40
CA45B035K155TA	35	1.5	1	6	5.2	128	115	51
CA45C035K155TA	35	1.5	1	6	4.5	156	141	63
CA45D035K155TA	35	1.5	1	6	4.5	183	164	73
CA45A035K225TA	35	2.2	1	6	4.5	129	116	52
CA45B035K225TA	35	2.2	1	6	4.2	142	128	57
CA45C035K225TA	35	2.2	1	6	3.5	177	160	71
CA45D035K225TA	35	2.2	1	6	3.5	207	186	83
CA45B035K335TA	35	3.3	1	6	3.5	156	140	62
CA45C035K335TA	35	3.3	1	6	2.5	210	189	84
CA45D035K335TA	35	3.3	1	6	2.5	245	220	98

**ELECTRONICAL CHARACTERISTICS- RATED VOLTAGE 35V, CAPACITANCE TOL. ±10% (K)**

Part Code	Rate Voltage ≤ 85°C	Cap. @25°C 100Hz	Max. Leakage Current @+25°C 5 min.	Max. Dissipation Factor (DF) @25°C 100Hz	ESR @25°C 100 KHz	Max. Ripple Current		
						@ 25°C 100KHz	@ 85°C 100KHz	@ 125°C 100KHz
	V	µF	µA	%	Ω	mA		
CA45B035K475TA	35	4.7	2	6	3.1	166	149	66
CA45C035K475TA	35	4.7	2	6	2.2	224	201	89
CA45D035K475TA	35	4.7	2	6	1.5	316	285	126
CA45E035K475TA	35	4.7	2	6	1.2	371	334	148
CA45B035K685TA	35	6.8	2	6	2.8	217	196	90
CA45C035K685TA	35	6.8	2	6	1.8	247	222	99
CA45D035K685TA	35	6.8	2	6	1.3	340	306	136
CA45E035K685TA	35	6.8	2	6	0.9	428	385	171
CA45C035K106TA	35	10	4	6	1.6	262	236	105
CA45D035K106TA	35	10	4	6	1	387	349	155
CA45E035K106TA	35	10	4	6	0.9	428	385	171
CA45C035K156TA	35	15	5	6	1.4	280	252	112
CA45D035K156TA	35	15	5	6	0.9	408	367	163
CA45E035K156TA	35	15	5	6	0.9	428	385	171
CA45C035K226TA	35	22	8	6	1.4	280	252	112
CA45D035K226TA	35	22	8	6	0.9	408	367	163
CA45E035K226TA	35	22	8	6	0.7	486	437	194
CA45V035K226TA	35	22	8	6	0.5	707	636	283
CA45D035K336TA	35	33	12	6	0.9	408	367	163
CA45E035K336TA	35	33	12	6	0.9	428	385	171



**ELECTRONICAL CHARACTERISTICS- RATED VOLTAGE 40V, CAPACITANCE TOL. ±10% (K)**

Part Code	Rate Voltage ≤ 85°C	Cap. @25°C 100Hz	Max. Leakage Current @+25°C 5 min.	Max. Dissipation Factor (DF) @25°C 100Hz	ESR @25°C 100 KHz	Max. Ripple Current		
						@ 25°C 100KHz	@ 85°C 100KHz	@ 125°C 100KHz
	V	µF	µA	%	Ω	mA		
CA45A040K474TA	40	0.47	1	4	9	91	82	37
CA45B040K474TA	40	0.47	1	4	9	97	87	39
CA45B040K684TA	40	0.68	1	4	6	119	107	48
CA45C040K684TA	40	0.68	1	4	7.5	121	109	48
CA45B040K105TA	40	1	1	4	5	130	117	52
CA45C040K105TA	40	1	1	4	6	135	122	54
CA45B040K155TA	40	1.5	1	6	4	146	131	58
CA45C040K155TA	40	1.5	1	6	4.5	156	141	63
CA45C040K225TA	40	2.2	1	6	2.5	210	189	84
CA45D040K225TA	40	2.2	1	6	3	224	201	89
CA45C040K335TA	40	3.3	1	6	2	235	211	94
CA45D040K335TA	40	3.3	1	6	2	274	246	110
CA45C040K475TA	40	4.7	2	6	1.5	271	244	108
CA45D040K475TA	40	4.7	2	6	1.5	316	285	126
CA45E040K475TA	40	4.7	2	6	1.5	332	298	133
CA45D040K685TA	40	6.8	3	6	1.2	354	318	141
CA45E040K685TA	40	6.8	3	6	1.2	371	334	148
CA45D040K106TA	40	10	4	6	0.9	408	367	163
CA45E040K106TA	40	10	4	6	0.9	428	385	171
CA45E040K156TA	40	15	6	6	0.7	486	437	194





**ELECTRONICAL CHARACTERISTICS- RATED VOLTAGE 50V, CAPACITANCE TOL. ±10% (K)**

Part Code	Rate Voltage ≤ 85°C	Cap. @25°C 100Hz	Max. Leakage Current @+25°C 5 min.	Max. Dissipation Factor (DF) @25°C 100Hz	ESR @25°C 100 KHz	Max. Ripple Current		
						@ 25°C 100KHz	@ 85°C 100KHz	@ 125°C 100KHz
	V	μF	μA	%	Ω	mA		
CA45A050K334TA	50	0.33	0.5	4	10	87	78	35
CA45A050K474TA	50	0.47	1	4	12	79	71	32
CA45B050K474TA	50	0.47	1	4	9.5	95	85	38
CA45C050K474TA	50	0.47	1	4	8	117	106	47
CA45A050K684TA	50	0.68	1	4	8	97	87	39
CA45B050K684TA	50	0.68	1	4	8	103	93	41
CA45C050K684TA	50	0.68	1	4	7	125	113	50
CA45A050K105TA	50	1	1	4	7	104	93	41
CA45B050K105TA	50	1	1	6	7	110	99	44
CA45C050K105TA	50	1	1	4	5.5	141	127	57
CA45D050K105TA	50	1	1	4	2.2	261	235	104
CA45E050K105TA	50	1	1	4	2.2	274	246	110
CA45B050K155TA	50	1.5	1	8	6	119	107	48
CA45C050K155TA	50	1.5	1	6	4.5	156	141	63
CA45D050K155TA	50	1.5	1	6	4	194	174	77
CA45B050K225TA	50	2.2	1	8	4.5	137	124	55
CA45C050K225TA	50	2.2	1	8	3	191	172	77
CA45D050K225TA	50	2.2	1	6	2.5	245	220	98
CA45E050K225TA	50	2.2	1	6	2	287	259	115
CA45C050K335TA	50	3.3	2	6	2.5	210	189	84

**ELECTRONICAL CHARACTERISTICS- RATED VOLTAGE 50V, CAPACITANCE TOL. ±10% (K)**

Part Code	Rate Voltage ≤ 85°C	Cap. @25°C 100Hz	Max. Leakage Current @+25°C 5 min.	Max. Dissipation Factor (DF) @25°C 100Hz	ESR @25°C 100 KHz	Max. Ripple Current		
						@ 25°C 100KHz	@ 85°C 100KHz	@ 125°C 100KHz
	V	µF	µA	%	Ω	mA		
CA45D050K335TA	50	3.3	2	6	2	274	246	110
CA45E050K335TA	50	3.3	2	6	1.8	303	272	121
CA45C050K475TA	50	4.7	2	6	1.5	271	244	108
CA45D050K475TA	50	4.7	2	6	1.4	327	295	131
CA45E050K475TA	50	4.7	2	6	1.2	371	334	148
CA45V050K475TA	50	4.7	2	6	1.2	456	411	183
CA45C050K685TA	50	6.8	3	6	1	332	298	133
CA45D050K685TA	50	6.8	3	6	1	387	349	155
CA45E050K685TA	50	6.8	3	6	0.9	428	385	171
CA45D050K106TA	50	10	5	6	0.8	433	390	173
CA45E050K106TA	50	10	5	6	0.8	454	409	182
CA45V050K106TA	50	10	5	6	0.7	598	538	239
CA45D050K156TA	50	15	8	8	0.8	433	390	173
CA45E050K156TA	50	15	8	8	0.8	454	409	182
CA45V050K156TA	50	15	8	6	0.7	598	538	239
CA45E050K226TA	50	22	11	10	0.6	524	472	210
CA45W050K226TA	50	22	11	6	0.4	791	712	316
CA45V050K226TA	50	22	11	8	0.4	791	712	316
CA45E050K336TA	50	33	17	8	0.9	428	385	171
CA45W050K336TA	50	33	17	8	0.6	645	581	258



**ELECTRONICAL CHARACTERISTICS- RATED VOLTAGE 63V, CAPACITANCE TOL. ±10% (K)**

Part Code	Rate Voltage ≤ 85°C	Cap. @25°C 100Hz	Max. Leakage Current @+25°C 5 min.	Max. Dissipation Factor (DF) @25°C 100Hz	ESR @25°C 100 KHz	Max. Ripple Current		
						@ 25°C 100KHz	@ 85°C 100KHz	@ 125°C 100KHz
	V	µF	µA	%	Ω	mA		
CA45C063K474TA	63	0.47	1	4	7	125	113	50
CA45C063K684TA	63	0.68	1	4	6	135	122	54
CA45C063K105TA	63	1	1	4	5	148	133	59
CA45D063K155TA	63	1.5	1	6	3.5	207	186	83
CA45D063K225TA	63	2.2	1	6	2	274	246	110
CA45D063K335TA	63	3.3	2	6	1.5	316	285	126
CA45D063K475TA	63	4.7	3	6	1	387	349	155
CA45E063K475TA	63	4.7	3	6	1	406	366	162
CA45D063K685TA	63	6.8	4	6	0.9	408	367	163
CA45E063K685TA	63	6.8	4	6	0.9	428	385	171
CA45V063K685TA	63	6.8	4	6	0.9	527	474	211
CA45D063K106TA	63	10	6	6	0.9	408	367	163
CA45E063K106TA	63	10	6	6	0.9	428	385	171
CA45V063K106TA	63	10	6	6	0.9	527	474	211
CA45E063K156TA	63	15	9	6	0.9	428	385	171
CA45V063K156TA	63	15	9	6	0.9	527	474	211
CA45E063K226TA	63	22	14	6	0.9	428	385	171
CA45V063K226TA	63	22	14	6	0.9	527	474	211
CA45W063K226TA	63	22	14	6	0.9	527	474	211

**ELECTRONICAL CHARACTERISTICS- RATED VOLTAGE 75V, 100V, CAPACITANCE TOL. ±10% (K)**

Part Code	Rate Voltage ≤ 85°C	Cap. @25°C 100Hz	Max. Leakage Current @+25°C 5 min.	Max. Dissipation Factor (DF) @25°C 100Hz	ESR @25°C 100 KHz	Max. Ripple Current		
						@ 25°C 100KHz	@ 85°C 100KHz	@ 125°C 100KHz
	V	µF	µA	%	Ω	mA		
CA45C075K474TA	75	0.47	1	4	7	125	113	50
CA45C075K684TA	75	0.68	1	4	6	135	122	54
CA45C075K105TA	75	1	1	4	4.5	156	141	63
CA45D075K105TA	75	1	1	4	4.5	183	164	73
CA45D075K155TA	75	1.5	1	6	3.5	207	186	83
CA45E075K225TA	75	2.2	2	6	1.8	303	272	121
CA45E075K335TA	75	3.3	2	6	1.3	356	321	143
CA45E075K475TA	75	4.7	4	6	0.9	428	385	171
CA45V075K475TA	75	4.7	4	6	0.9	527	474	211
CA45C100K474TA	100	0.47	1	4	6.5	130	117	52
CA45C100K684TA	100	0.68	1	4	5	148	133	59
CA45D100K684TA	100	0.68	1	4	5	173	156	69
CA45D100K105TA	100	1	1	4	4.5	183	164	73
CA45E100K225TA	100	2.2	2	6	1.5	332	298	133
CA45V100K225TA	100	2.2	2	6	1.5	408	367	163

**APPLICATION NTOE**

**STORAGE CONDITION**

- Environmental temperature: 10°C ~ +30°C
- Relative humidity no more than 60%
- Storing period: No more than one and half year since the date of stocking.

**APPLICATION GUIDE**

1) Ripple Current and Voltage

If the ripple current is applied to the capacitor, the Joule heat (power dissipated) will be generated in the capacitor, so it will affect the reliability of the capacitor.

(1) Power Dissipated

The actual power dissipated can be calculated using the following formula:  $P=I^2 \times ESR$ .....Formula 1

P: Power dissipated (W); I: Ripple current (A); ESR: Equivalent series resistance ( $\Omega$ )

(2) Ripple Current

Using the maximum power dissipation 125mW Max., the ripple current can be calculated using the following

formula:  $I= \sqrt{\frac{P}{ESR}} \times K \times F$ .....Formula 2

K: Temperature derating factor..... Table 1; F: Frequency derating factor..... Table 2

ESR: Refer to the ratings of each specific product

Table 1: Temperature Drop Factor K

Temperature	Temperature Derating Factor K
25 °C	1
85 °C	0.9
125 °C	0.4

Table 2: Frequency Derating Factor F

Frequency (KHz)	10	100	500	1000
MnO2	0.80	1.0	1.15	1.20
Polymer	0.75	1.0	1.10	1.30

### (3) Ripple Voltage

The ripple voltage applied to the capacitor is limited by three criteria.

- (a) The power dissipation in the ESR of capacitor must not exceed 125mW Max. @+25°C
- (b) The positive peak AC voltage plus the DC bias voltage must not exceed the DC voltage rating of the capacitor.
- (c) The negative peak AC voltage, in combination with the bias voltage, if any , must not exceed the permissible reverse voltage ratings presented .

### 2) Reverse Voltage

Solid tantalum capacitors are polarized devices , and applied reverse voltage can not be allowed . If the reverse voltage is unavoidable, a small degree of transient reverse voltage is permissible for short periods as follow.

25°C..... 10% of Max. rated voltage or 1V whichever is smaller

85°C..... 5% of Max. rated voltage or 0.5V whichever is smaller

125°C.....1% of Max. rated voltage or 0.1V whichever is smaller

Even under these restrictions, capacitors can not be used continuously in reverse voltage mode.

### 3) Working Voltage

- (1) For general applications, using 50% of rated voltage of capacitors or less.
- (2) When used at the power circuit, low impedance circuit , coupling circuit or witching circuit which has leakage current problems, please design the circuit with voltage under 30% of the working voltage ( max 50%) to avoid the adverse effect of the surge current.

(3) Derating voltage when temperature above 85°C.

When the chip tantalum capacitor is used at 85°C or more temperatures, the reduced voltage ( $U_T$ ) is calculated from the following expression, however, note that the ambient temperature is not more than 125°C.

$$U_T = V_0 (U_R - U_C)(T - 85) / 40$$

$U_R$ : Rated voltage (V);  $U_C$ : Derating voltage at 125°C; T: Ambient temperature (°C )



#### 4) Protective Resistance

In a circuit (switching circuit, charge / discharge circuit, etc.) that has an instantaneous current, series resistance is at least  $3\Omega/V$ , this can improve the reliability of tantalum capacitors. If the capacitor is in a low impedance circuit, the voltage applied to the capacitor should be half or one third of the rated voltage.

#### 5) Redundancy

MnO<sub>2</sub> tantalum capacitors will heat, and may cause fire and burn in the short circuit. This is determined by the situation, time and other factors. When the circuit is designed, it is possible to provide the best possible space to keep the tantalum capacitor reliability.

#### 6) Test Condition

Ambient Temperature 25°C; Relative Humidity 60 to 70%; Air Pressure 800 to 1060mbar. Test and experiment, in order to make the test results not problems, it is necessary to will test the product after fully discharge.

This product is a polar components, testing or when using it is strictly prohibited to will is negative pick back, in order to avoid performance failure

#### 7) Soldering

The SMD tantalum capacitor can be used for reflow soldering, which is not suitable for wave soldering and manual welding. The reflow temperature are  $\leq 250^{\circ}\text{C}$ ,  $\leq 5$  seconds. If you must use manual welding, should use the melted solder to contact lead, and the electric soldering iron power should be less than or equal to 25W, temperature should be less than  $300^{\circ}\text{C}$ , welding time should be less than 3 seconds, can not use electric iron contact the product lead directly, and in particular, can not contact the product ontology directly. Recommended profile conditions for convection and IR reflow reflect the profile conditions of the IPC/J-STD-020D standard for moisture sensitivity testing

RECOMMENDED PROFILE CONDITIONS –Only For reference

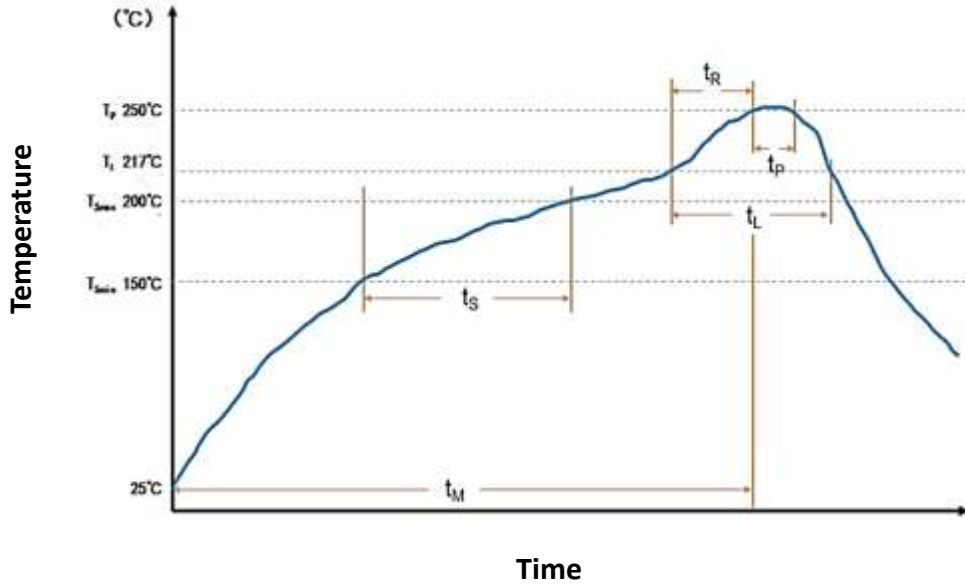

CHARACTERISTICS	UNIT	SYMBOL	SnPb ASSEMBLY	Pb-Free ASSEMBLY
Preheat Temperature Min.	°C	T smin	100	150
Preheat Temperature Max.	°C	T smax	150	200
Preheat time	Second	T s	60~120	60~120
Ramp-up Rate	°C/Second	T L to T p	≤ 3	≤ 3
Liquidous Temperature	°C	T L	183	217
Time Above Liquidous	Second	t L	60~150	60~150
Peak Temperature	°C	T p	220 or 235	245 or 250
Time within 5°C Max. Peak Temperature	Second	t p	≤ 10	≤ 3
Ramp-down Rate	°C/Second	T p to T L	≤ 6	≤ 6
Time 25°C to Peak Temperature	minute		≤ 6	≤ 6

RECOMMENDED VOLTAGE DERATING GUIDELINES – Only For reference

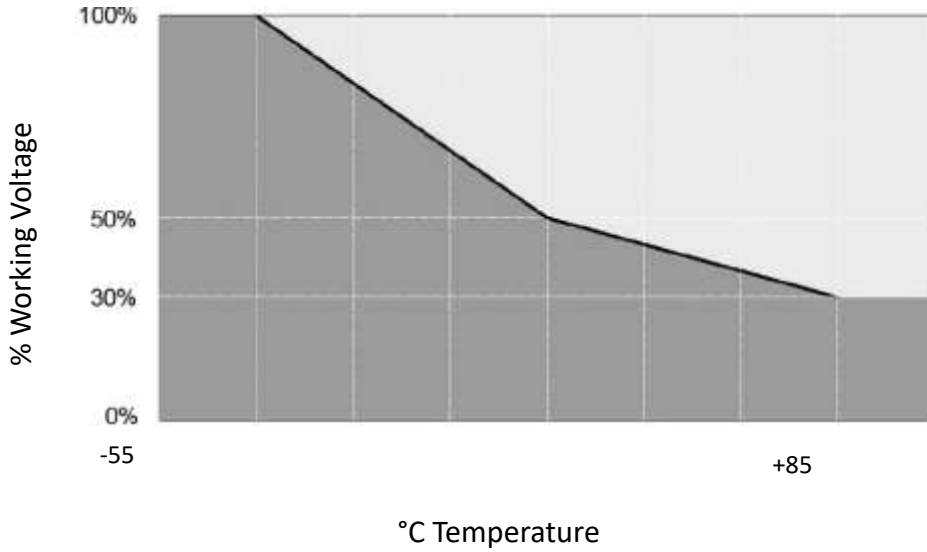

CONDITION	-55 °C ~ 85 °C
% Change in Working DC Voltage with Temperature	V <sub>R</sub>
Recommended Max. Application @V <sub>R</sub> ≤10V	50 of V <sub>R</sub>
Recommended Max. Application @V <sub>R</sub> ≥16V	30% of V <sub>R</sub>

TAPE DIMENSION (Unit: mm) Tolerance  $\pm 0.2$ mm over 10 sprocket hole spaces

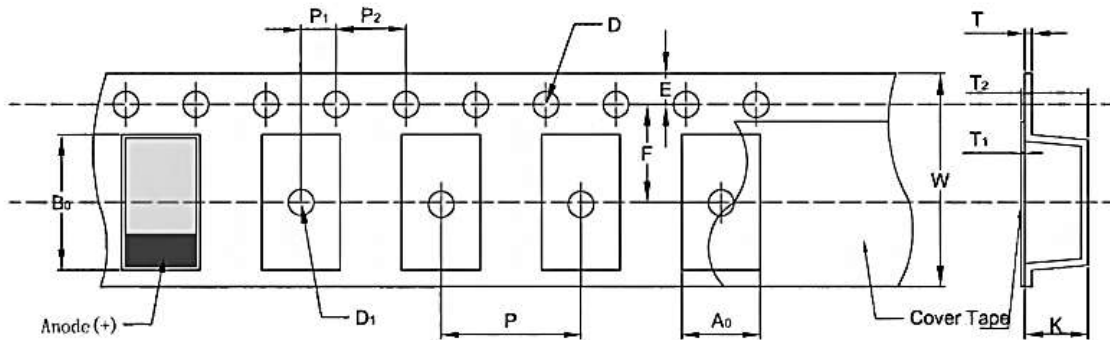

CASE SIZE CODE	DIMENSION										
	A0	B0	K	W	E	F	P2	P	P1	D	D1
	$\pm 0.1$	$\pm 0.1$	$\pm 0.1$	$\pm 0.3$	$\pm 0.1$	$\pm 0.05$	$\pm 0.1$	$\pm 0.05$	$\pm 0.1$	$+0.2$	$+0.25$
A	1.88	3.53	1.90	8.00	1.75	3.50	4.00	4.00	2.00	1.55	1.00
B1	3.07	3.80	2.22	8.00	1.75	3.50	4.00	4.00	2.00	1.55	1.10
B	3.07	3.80	2.22	8.00	1.75	3.50	4.00	4.00	2.00	1.55	1.10
C	3.60	6.40	2.85	12.00	1.75	5.50	4.00	8.00	2.00	1.55	1.60
H1	4.60	7.60	2.16	12.00	1.75	5.50	4.00	8.00	2.00	1.55	1.55
L	4.60	7.60	2.16	12.00	1.75	5.50	4.00	8.00	2.00	1.55	1.55
H	4.60	7.60	2.16	12.00	1.75	5.50	4.00	8.00	2.00	1.55	1.55
F	6.50	7.80	2.20	12.00	1.75	5.50	4.00	8.00	2.00	1.55	1.50
D	4.60	7.60	3.10	12.00	1.75	5.50	4.00	8.00	2.00	1.55	1.55
Y	4.60	7.60	3.10	12.00	1.75	5.50	4.00	8.00	2.00	1.55	1.55
E	4.60	7.60	4.40	12.00	1.75	5.50	4.00	8.00	2.00	1.55	1.55
V	6.40	7.60	4.40	12.00	1.75	5.50	4.00	8.00	2.00	1.55	1.55
W	6.50	8.00	4.70	16.00	1.75	7.50	4.00	12.00	2.00	1.55	1.55

REEL DIMENSION (Unit: mm)

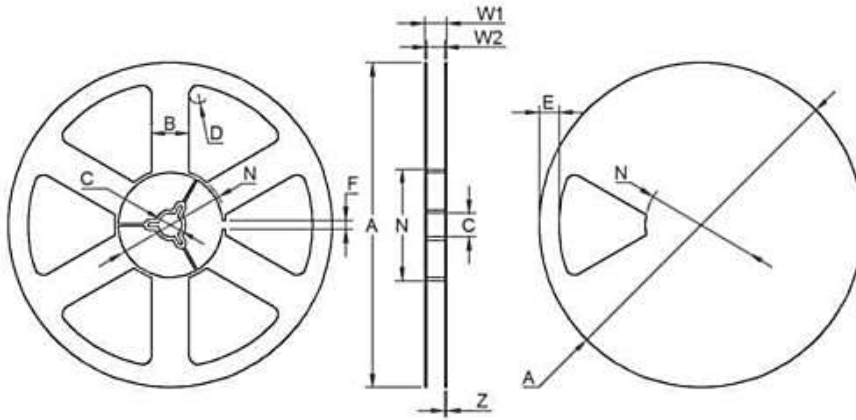

REEL SIZE	TAPE WIDE	DIMENSION				
		A	B	C	W2	W1
7" (180 mm)	8	178±2.0	50 Min.	13.2±0.5	8.4+1.5/-0	10.8+1.5/-0
7" (180 mm)	12	178±2.0	50 Min.	13.2±0.5	12.4+1.5/0	14.8+1.5/-0
7" (180 mm)	16	178±2.0	50 Min.	13.2±0.5	16.0+1.5/-0	19.0+1.5/-0
13" (330 mm)	12	330±2.0	50 Min.	13.2±0.5	12.4+1.5/-0	16.5+1.5/-0

QTY PER REEL (Unit: pcs)

CASE SIZE CODE	A	B1	B	C	H1	L	H	F	D	Y	E	V	W
Qty.	2000	2000	2000	500	1000	1000	1000	1000	500	500	500	400	400

## IMPORTANT NOTES AND DISCLAIMER

1. **ROHS COMPLIANCE:** The levels of RoHS restricted materials in this product are below the maximum concentration values (also referred to as the threshold limits) permitted for such substances, or are used in an exempted application, in accordance with EU RoHS Directive (EU) 2015/863 EC (RoHS3). RoHS Test Report for this product can be obtained at Download Center.
2. **REACH COMPLIANCE:** REACH substances of high concern (SVHCs) information is available for this product. Since the European Chemical Agency (ECHA) has published notice of their intent to frequently revise the SVHC listing for the foreseeable future, REACH Test Report for this product can be obtained at Download Center.
3. All Product parametric performance is indicated in the Electrical Characteristics for the listed herein test conditions, unless otherwise noted. Product performance may not be indicated by the Electrical Characteristics if operated under different conditions.
4. NextGen Component, Inc (*NextGen*) reserves the right to make changes to this document and its products and specifications at any time without notice. Customers should obtain and confirm the latest product information and specifications before final design, purchase or use.
5. *NextGen* makes no warranty, representation or guarantee regarding the suitability of its products for any particular purpose, not does *NextGen* assume any liability for application assistance or customer product design.
6. *NextGen* does not warrant or accept any liability with products which are purchased or used for any unintended or unauthorized application. No license is granted by implication or otherwise under any intellectual property rights of NextGen.
7. *NextGen* products are not authorized for use as critical components in life support devices or systems without express written approval by *NextGen*.
8. *NextGen* requires that customers first obtain an RMA (Returned Merchandise Authorization) number prior to returning any products. Returns must be made within 30 days of the date of invoice, be in the original packaging, unused and like-new condition. At the time of quoting or purchasing, a product may say that it is Non-Cancelable/ Non-Returnable (NCNR). These products are not returnable and not refundable.