





SPECIFICATION SHEET NO.	S1229- BZT52B2V7LS001	
ORIGINAL MFG/PART NO.	 LGE Diodes/BZT52B2V7-L	
NEXTGEN PART CODE	BZT52B2V7LS001	Indicate This Code For RFQ /Order
DATE	Dec. 29, 2025	
REVISION	A4	Updated With Most Recent Data
DESCRIPTION AND MAIN PARAMETRICS	<p>SMD Zener Diodes, Case SOD-123, BZT52B L series, BZT52B2V7 Type, 2 Pads Nominal Zener Voltage (Vz): 2.7V, Power Dissipation: 500 mW Junction Temp. Range 150°C Package in Tape/Reel, 3000pcs/Reel RoHS/RoHS III compliant, RoHS Annex III lead Exemption (Exempt per RoHS EU 2015/863) and Halogen Free (HF)</p>	
CUSTOMER		
CUSTOMER PART NUMBER		
CROSS REF. PART NUMBER		
MEMO		

VENDOR APPROVE			
Issued/Checked/Approved			
Effective Date: Dec. 29, 2025			

CUSTOMER APPROVE	
Date:	

MAIN FEATURE

- SOD-123 Plastic-Encapsulate Diodes
- 500mw Power Dissipation on Ceramic PCB.
- Vz Tolerance selection of $\pm 2\%$ (B series).
- Wide Zener Reverse Voltage Range 2.4V To 75V.
- Small Plastic Package Suitable For Surface Mounted Design.
- Cross Competitors Parts and More.
- RoHS/RoHS III compliant, RoHS Annex III lead Exemption (Exempt per RoHS EU 2015/863) and Halogen Free (HF)



Image shown is a representation only. Exact specifications should be obtained from the product dimension.

APPLICATION

- For SMD Application

ELECTRICAL CHARACTERISTICS

- See Page 5 ~ Page 7 For Different Part Code .
- All Products Parameters are Subject To NextGen Components' Final Confirmation.



HOW TO ORDER

- Please Follow Up Part Code Guide And Indicate NextGen Part Code [BZT52B2V7LS001](#) For RFQ and Order.

PART CODE GUIDE

RFQ
[Request For Quotation](#)

CODE	NAME	KEY SPECIFICATION OPTION
BZT52B	Product Series Code	SMD Zener Diodes, 2 Pads, Case SOD-123, BZT52B L series,
2V7	Parameters Code	2V7: Nominal Zener Voltage 2.7V
LS001	Internal Control Code	Letter or Digits (A~Z, a~z or 0~9)
XX	Special/Custom Parameters Code	Letter or Digits (A~Z, a~z or 0~9) for Special Parametric; Blank: N/A

DIMENSION -- Unit: Inch (mm), Case SOD-123 Outline

Top View

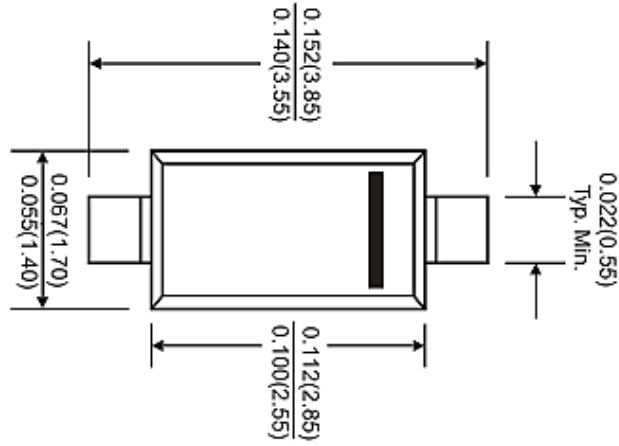

Side View

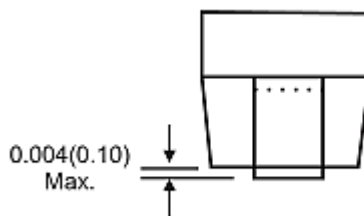
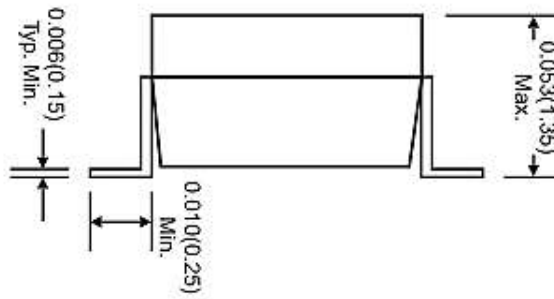

Equivalent Circuit

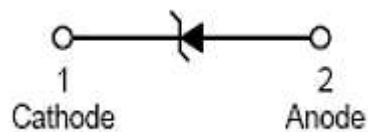

MECHANICAL CHARACTERISTICS

CASE	TERMINALS	POLARITY	MOUNTING POSITION	MARKING
JEDEC SOD-123 Molded Plastic Body	Solderable per MIL-STD-750, Method 2026	Polarity Symbol Marking On Body	Any	See Page 6 ~ Page 7

MAX. RATING - $T_A=25^{\circ}\text{C}$ unless otherwise specified, For Reference Only

PARAMETER	SYMBOLS	VALUE	UNITS
Forward Voltage @ $I_F = 10\text{mA}$	V_F	0.9	V
Power Dissipation	P_D	500	mW
Thermal Resistance From Junction To Ambient Air	$R_{\theta JA}$	305	$^{\circ}\text{C}/\text{W}$
Junction Temperature Range	T_J	150	$^{\circ}\text{C}$
Storage Temperature Range	T_{stg}	-65 ~ +150	$^{\circ}\text{C}$

Notes

1. The Zener voltage (V_Z) is tested under pulse condition of 10ms..
2. The device numbers listed have a standard tolerance on the nominal Zener voltage of $\pm 2\%$.
3. The Zener impedance is derived from the 60-cycle ac voltage, which results when an ac current having a rms value equal to 10% of the dc Zener current (I_{ZT} or I_{ZK}) is superimposed to I_{ZT} or I_{ZK} .
4. These ratings are limiting values above which the serviceability of the diodes may be impaired.

ELECTRICAL CHARACTERISTICS - Ta=25°C unless otherwise specified

Part Code	Zener Voltage Range				Max. Zener Impedance			Max. Reverse Current		Marking
	Vz @ Izt			IzT	ZzT @ IzT	ZzK @ IzK	IzK	IR	@ VR	
	Nom (V)	Min (V)	Max (V)	mA	Ω		mA	μA	V	
BZT52B2V4LS001	2.4	2.35	2.45	5	94	564	1	45	1	2WX
BZT52B2V7LS001	2.7	2.65	2.75	5	94	564	1	18	1	2W1
BZT52B3V0LS001	3.0	2.94	3.06	5	89	564	1	9	1	2W2
BZT52B3V3LS001	3.3	3.23	3.37	5	89	564	1	4.5	1	2W3
BZT52B3V6LS001	3.6	3.53	3.67	5	84	564	1	4.5	1	2W4
BZT52B3V9LS001	3.9	3.82	3.98	5	84	564	1	2.7	1	2W5
BZT52B4V3LS001	4.3	4.21	4.39	5	84	564	1	2.7	1	2W6
BZT52B4V7LS001	4.7	4.61	4.79	5	75	564	1	2.7	2	2W7
BZT52B5V1LS001	5.1	5.00	5.20	5	56	470	1	1.8	2	2W8
BZT52B5V6LS001	5.6	5.49	5.71	5	37	451	1	0.9	2	2W9
BZT52B6V2LS001	6.2	6.08	6.32	5	9	376	1	2.7	4	2WA
BZT52B6V8LS001	6.8	6.66	6.94	5	14	141	1	1.8	4	2WB
BZT52B7V5LS001	7.5	7.35	7.65	5	14	75	1	0.9	5	2WC
BZT52B8V2LS001	8.2	8.04	8.36	5	14	75	1	0.63	5	2WD
BZT52B9V1LS001	9.1	8.92	9.28	5	14	94	1	0.45	6	2WE
BZT52B10L0S001	10	9.80	10.20	5	18	141	1	0.18	7	2WF
BZT52B11L0S001	11	10.78	11.22	5	18	141	1	0.09	8	2WG
BZT52B12L0S001	12	11.76	12.24	5	23	141	1	0.09	8	2WH
BZT52B13L0S001	13	12.74	13.26	5	28	160	1	0.09	8	2WI
BZT52B15L0S001	15	14.70	15.30	5	28	188	1	0.045	10.5	2WJ

ELECTRICAL CHARACTERISTICS - Ta=25°C unless otherwise specified

Part Code	Zener Voltage Range				Max. Zener Impedance			Max. Reverse Current		Marking
	Vz @ Izt			Izt	Zzt @ Izt	Zzk @ Izk	Izk	IR	@ VR	
	Nom (V)	Min (V)	Max (V)	mA	Ω		mA	μA	V	
BZT52B16LOS001	16	15.68	16.32	5	37	188	1	0.045	11.2	2WK
BZT52B18LOS001	18	17.64	18.36	5	42	212	1	0.045	12.6	2WL
BZT52B20LOS001	20	19.60	20.40	5	51	212	1	0.045	14.0	2WM
BZT52B22LOS001	22	21.56	22.44	5	51	235	1	0.045	15.4	2WN
BZT52B24LOS001	24	23.52	24.48	5	65	235	1	0.045	16.8	2WO
BZT52B27LOS001	27	26.46	27.54	2	75	282	0.5	0.045	18.9	2WP
BZT52B30LOS001	30	29.40	30.60	2	75	282	0.5	0.045	21.0	2WQ
BZT52B33LOS001	33	32.34	33.66	2	75	306	0.5	0.045	23.0	2WR
BZT52B36LOS001	36	35.28	36.72	2	84	329	0.5	0.045	25.2	2WS
BZT52B39LOS001	39	38.22	39.78	2	122	329	0.5	0.045	27.3	2WT
BZT52B43LOS001	43	42.14	43.86	2	141	353	0.5	0.045	30.1	2WU
BZT52B47LOS001	47	46.06	47.94	2	160	375	0.5	0.045	35.0	2WV
BZT52B51LOS001	51	50.00	52.00	2	180	400	0.5	0.045	35.7	2WW
BZT52B56LOS001	56	54.90	57.10	2	200	425	0.5	0.045	39.2	X2
BZT52B62LOS001	62	60.80	63.20	2	215	450	0.5	0.045	43.4	X3
BZT52B68LOS001	68	66.64	69.36	2	240	475	0.5	0.045	47.6	X4
BZT52B75LOS001	75	73.50	76.50	2	255	500	0.5	0.045	52.5	X5

TYPICAL CHARACTERISTICS CURVES- For Reference Only, $T_a=25^\circ\text{C}$ Unless Otherwise Specified.

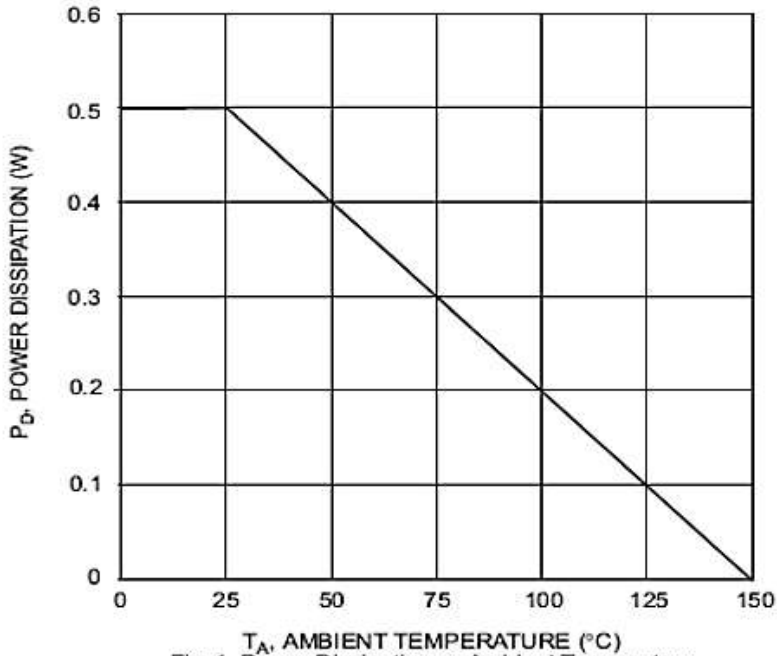

Fig. 1 Power Dissipation vs Ambient Temperature

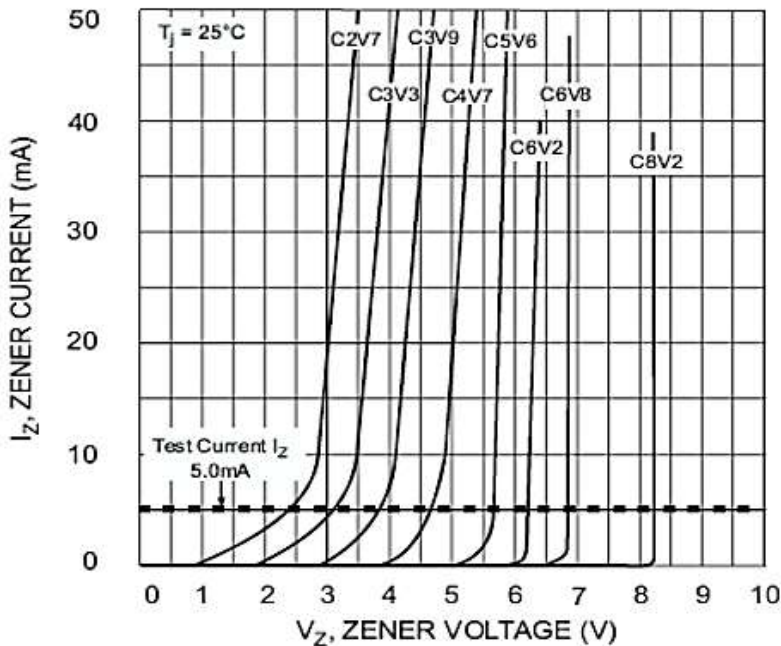

Fig. 2 Zener Breakdown Characteristics

TYPICAL CHARACTERISTICS CURVES- For Reference Only, $T_a=25^\circ\text{C}$ Unless Otherwise Specified.

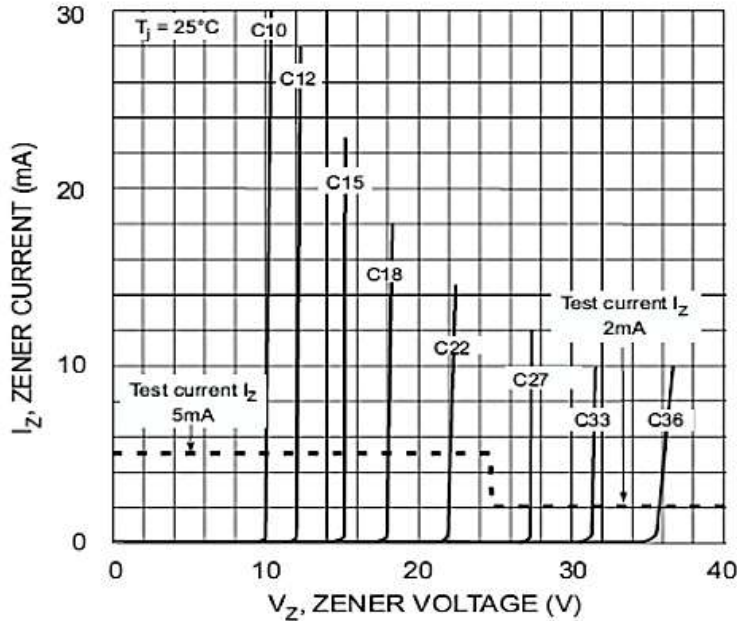

Fig. 3 Zener Breakdown Characteristics

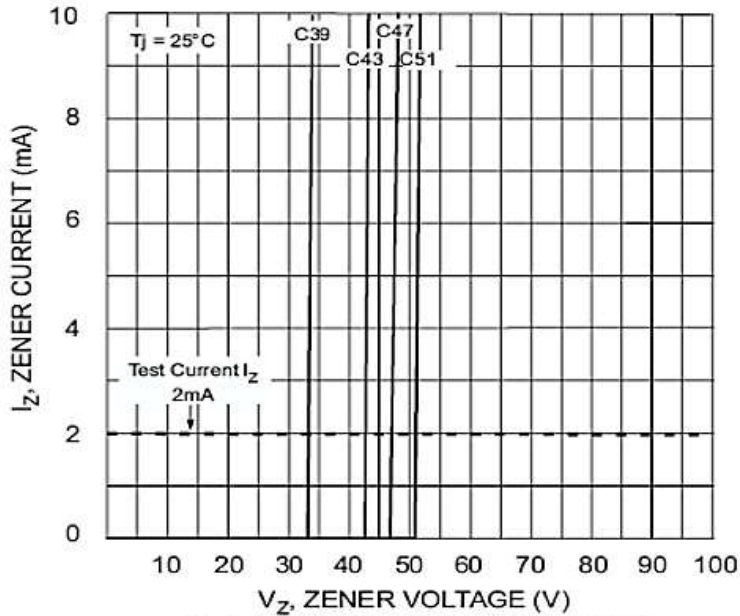

Fig. 4 Zener Breakdown Characteristics

TYPICAL CHARACTERISTICS CURVES- For Reference Only, $T_a=25^\circ\text{C}$ Unless Otherwise Specified.

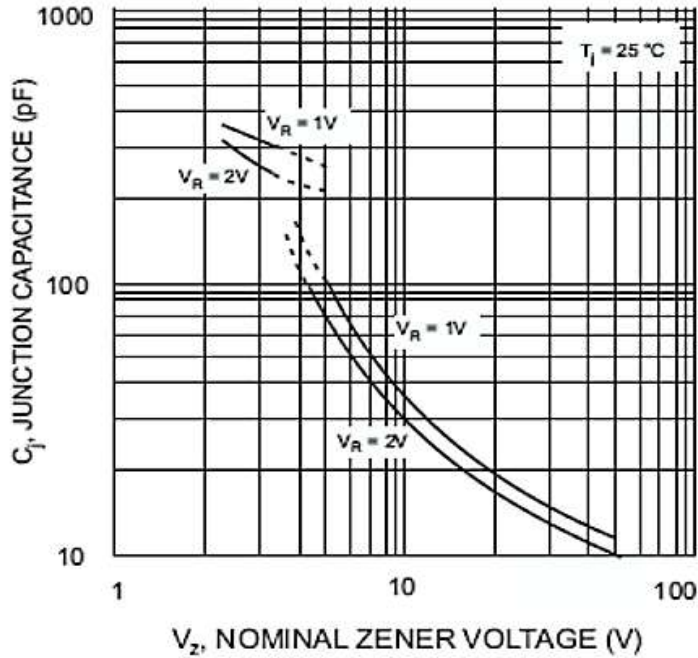
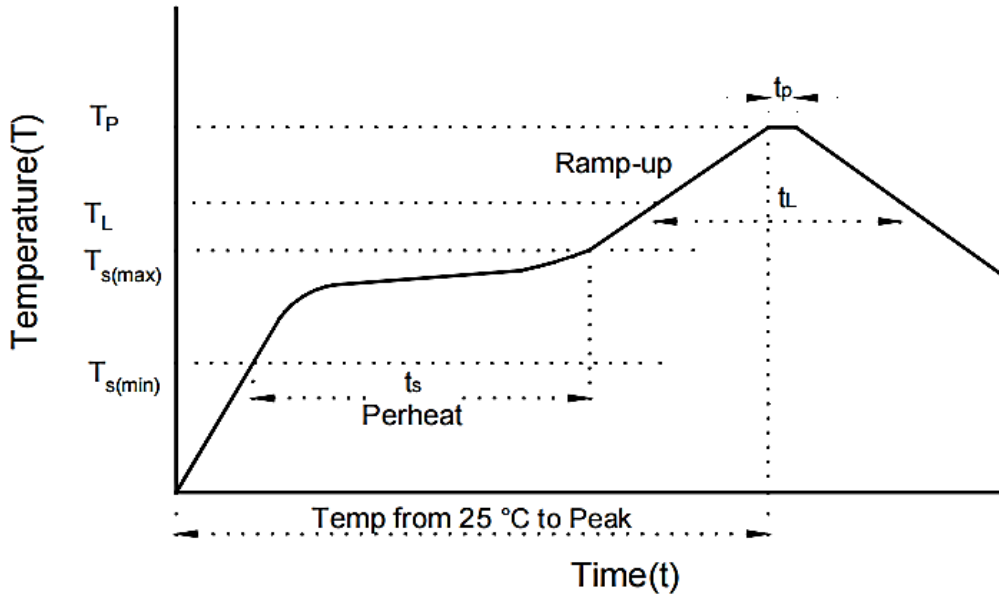

Fig. 5 Junction Capacitance vs Nominal Zener Voltage

SUGGESTED REFLOW PROFILE - For Reference Only



PROFILE FEATURE		PB-FREE ASSEMBLY
Average Ramp-up Rate (T_L Max to T_p)		3°C/second Max
Preheat	Temperature Min (T_s Min.)	150°C
	Temperature Max (T_s Max.)	200°C
	Time (t_s Min. to t_s Max.)	60 ~ 180 seconds
Time maintained above	Temperature (T_l)	217°C
	Time (t_l)	60 ~ 150 seconds
Peak/Classification Temperature (T_p)		260 °C
Time within 5°C of actual Peak Temperature (t_p)		10 seconds Max.
Ramp-down Rate		6 °C /Second Max.
Time 25 °C to Peak Temperature		8 Minutes Max.
Suggest reflow times		3 Times Max.

TAPE/REEL - Unit: mm, All Devices are packed in accordance with EIA standard RS-481-A and specifications

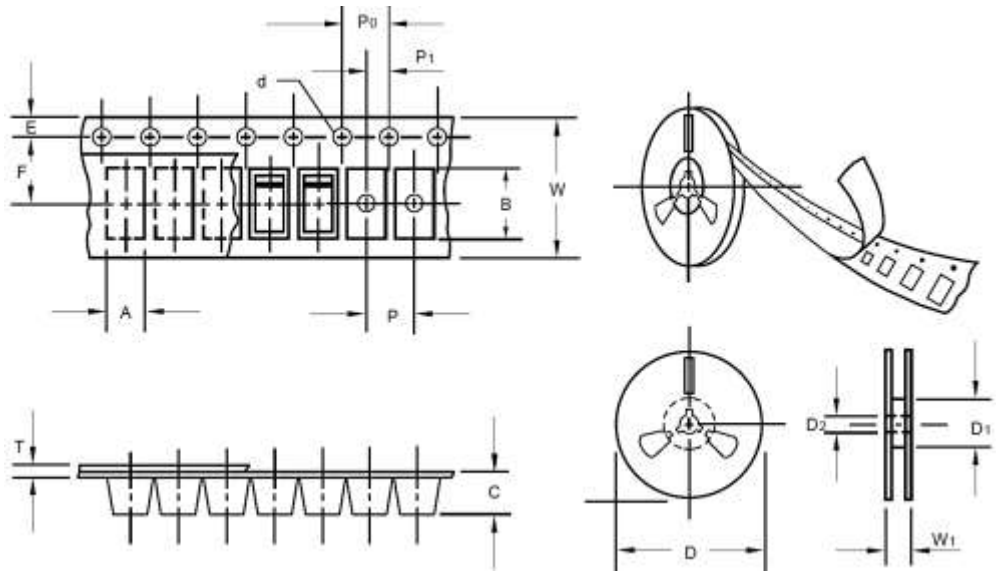

ITEM	SYMBOL	TOLERANCE	CASE SOD-123
Carrier width	A	0.1	2.10
Carrier Length	B	0.1	4.00
Carrier Depth	C	0.1	1.60
Sprocket hole	d	0.05	1.55
13" Reel outside diameter	-	-	-
13" Reel inner diameter	-	-	-
7" Reel outside diameter	D	2.0	178.00
7" Reel inner diameter	D1	Min.	50.00
Feed hole diameter	D2	0.5	13.00
Sprocket hole position	E	0.1	1.75
Punch hole position	F	0.1	3.50
Punch hole pitch	P	0.1	4.00
Sprocket hole pitch	P0	0.1	4.00
Embossment center	P1	0.1	2.00
Overall tape thickness	T	0.1	0.25
Tape width	W	0.3	8.15
Reel width	W1	1.0	10.50
MPQ/Reel	3000pcs/Reel		

IMPORTANT NOTES AND DISCLAIMER

1. **ROHS COMPLIANCE:** The levels of RoHS restricted materials in this product are below the maximum concentration values (also referred to as the threshold limits) permitted for such substances, or are used in an exempted application, in accordance with EU RoHS Directive (EU) 2015/863 EC (RoHS3). RoHS Test Report for this product can be obtained at Download Center.
2. **REACH COMPLIANCE:** REACH substances of high concern (SVHCs) information is available for this product. Since the European Chemical Agency (ECHA) has published notice of their intent to frequently revise the SVHC listing for the foreseeable future, REACH Test Report for this product can be obtained at Download Center.
3. All Product parametric performance is indicated in the Electrical Characteristics for the listed herein test conditions, unless otherwise noted. Product performance may not be indicated by the Electrical Characteristics if operated under different conditions.
4. NextGen Component, Inc (*NextGen*) reserves the right to make changes to this document and its products and specifications at any time without notice. Customers should obtain and confirm the latest product information and specifications before final design, purchase or use.
5. *NextGen* makes no warranty, representation or guarantee regarding the suitability of its products for any particular purpose, not does *NextGen* assume any liability for application assistance or customer product design.
6. *NextGen* does not warrant or accept any liability with products which are purchased or used for any unintended or unauthorized application. No license is granted by implication or otherwise under any intellectual property rights of NextGen.
7. *NextGen* products are not authorized for use as critical components in life support devices or systems without express written approval by *NextGen*.
8. *NextGen* requires that customers first obtain an RMA (Returned Merchandise Authorization) number prior to returning any products. Returns must be made within 30 days of the date of invoice, be in the original packaging, unused and like-new condition. At the time of quoting or purchasing, a product may say that it is Non-Cancelable/ Non-Returnable (NCNR). These products are not returnable and not refundable.