





SPECIFICATION SHEET NO.	S1225 – DZL4761L00S761	
ORIGINAL MFG/PART NO.	 LGE Diodes/DZL4761-L	
NEXTGEN PART CODE	DZL4761L00S761	Indicate This Code For RFQ /Order
DATE	Dec. 25, 2025	
REVISION	A4	Updated With Most Recent Data
DESCRIPTION AND MAIN PARAMETRICS	<p>SMD Zener Diodes 2 Pads, Case SOD-123FL, DZL4 L Series, Zener Voltage (Vz) 75V Nom. Power Dissipation at Ta=25°C: 1.0 Watts. Operating Junction Temperature Range (TJ) +150°C Package in Tape/Reel, 3000pcs/Reel RoHS/RoHS III compliant, RoHS Annex III lead Exemption (Exempt per RoHS EU 2015/863) and Halogen Free (HF)</p>	
CUSTOMER		
CUSTOMER PART NUMBER		
CROSS REF. PART NUMBER		
MEMO		

VENDOR APPROVE			
Issued/Checked/Approved			
Effective Date: Dec. 25, 2025			

CUSTOMER APPROVE	
Date:	

MAIN FEATURE

- For Surface Mounted Applications In Order To Optimize Board Space.
- Low Profile Space.
- Glass Passivated Chip.
- High Reliability.
- For Use In Stabilizing And Clipping Circuits With High Power Rating.
- Meet MSL 1 Requirement
- Component in accordance to WEEE 2002/95/EC and WEEE 2002/96/EC.
- Cross Competitors Parts and More.
- RoHS/RoHS III compliant, RoHS Annex III lead Exemption (Exempt per RoHS EU 2015/863) and Halogen Free (HF)



Image shown is a representation only. Exact specifications should be obtained from the product dimension.



APPLICATION

- For Voltage Stabilization.

ELECTRICAL CHARACTERISTICS

- See Page 5 ~ Page 7.
- All Products Parameters are Subject To NextGen Components' Final Confirmation.

HOW TO ORDER

- Please Follow Up Part Code Guide And Indicate NextGen Part Code DZL4761L00S761 For RFQ and Order.

PART CODE GUIDE

RFQ
[Request For Quotation](#)

CODE	NAME	KEY SPECIFICATION OPTION
DZL4	Product Series Code	SMD Zener Diodes 2Pads, Case SOD-123FL, DZL4 L Series
761	Parameters Code	Letter or Digits (A~Z, a~z or 0~9)
L00S	Internal Control Code	Letter A~Z, a-z or Digits (0-9)
761	Marking Code	Marking "761"
XX	Special/Custom Parameters	Blank: N/A; XX: Letter A~Z, a~z or digits (0~9) for Special/Custom Parameters

DIMENSION -- Unit: Inch (mm), Case SOD-123FL Outline

Top View

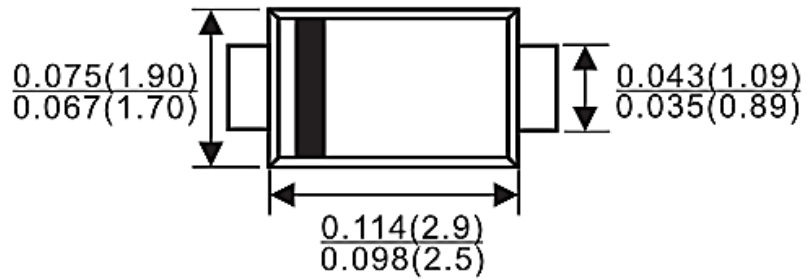

Side View

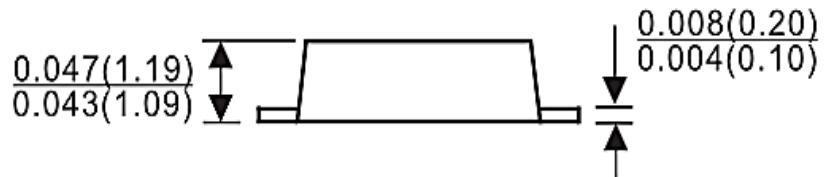

Bottom View

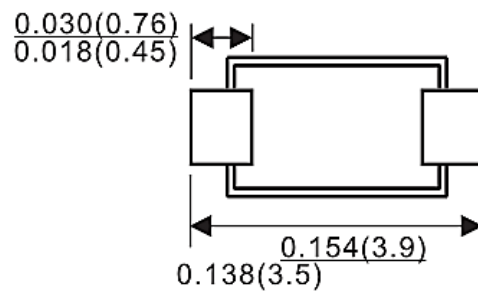

MECHANICAL CHARACTERISTICS

CASE	TERMINALS	POLARITY	MOUNTING POSITION	WEIGHT
JEDEC SOD-123FL Molded Plastic Body Over Passivated Chip	Solder Plated, Solderable per MIL-STD-750 Method 2026	Laser Band Denotes Cathode End	Any	0.017 Gram

MAX. RATINGS & ELECTRICAL CHARACTERISTICS

- Ratings at 25 °C ambient temperature unless otherwise specified.

Parameter	SYMBOLS	VALUE	UNITS
Power Dissipation	P _D	1.0	W
Typical Thermal Resistance Junction To Ambient	R _{θJA}	55	°C/W
Typical Thermal Resistance Junction To Lead	R _{θJL}	-	°C/W
Operating Junction Temperature Range	T _J	150	°C
Storage Temperature Range	T _{stg}	-55 ~ +150	°C

ELECTRICAL CHARACTERISTICS - Ta=25°C unless otherwise specified

Part Code	Zener Voltage Range V _{ZT} @ I _{ZT} (V)			Test Current I _{ZT} (mA)	Zener Impedance			Leakage Current		Marking Code
	Min.	Nom	Max.		Z _{ZT} @ I _{ZT} (Ω)	Z _{ZK} @I _{ZK}		Max. I _R (μA)	@ V _R (V)	
						(Ω)	mA			
DZL4728L00S728	3.13	3.3	3.47	76	10	400	1.0	100	1.0	728
DZL4729L00S729	3.42	3.6	3.78	69	10	400	1.0	100	1.0	729
DZL4730L00S730	3.70	3.9	4.10	64	9	400	1.0	50	1.0	730
DZL4731L00S731	4.08	4.3	4.52	58	9	400	1.0	50	1.0	731
DZL4732L00S732	4.46	4.7	4.94	53	8	500	1.0	10	1.0	732
DZL4733L00S733	4.84	5.1	5.36	49	7	550	1.0	10	1.0	733
DZL4734L00S734	5.32	5.6	5.88	45	5	600	1.0	10	2.0	734
DZL4735L00S735	5.89	6.2	6.51	41	2	700	1.0	10	3.0	735
DZL4736L00S736	6.46	6.8	7.14	37	3.5	700	1.0	10	4.0	736
DZL4737L00S737	7.12	7.5	7.88	34	4	700	0.5	10	5.0	737
DZL4738L00S738	7.79	8.2	8.61	31	4.5	700	0.5	10	6.0	738
DZL4739L00S739	8.64	9.1	9.56	28	5	700	0.5	10	7.0	739
DZL4740L00S740	9.50	10	10.50	25	7	700	0.25	10	7.6	740
DZL4741L00S741	10.45	11	11.55	23	8	700	0.25	5	8.4	741
DZL4742L00S742	11.40	12	12.60	21	9	700	0.25	5	9.1	742
DZL4743L00S743	12.35	13	13.65	19	10	700	0.25	5	9.9	743
DZL4744L00S744	14.25	15	15.75	17	14	700	0.25	5	11.4	744
DZL4745L00S745	15.20	16	16.80	15.5	16	700	0.25	5	12.2	745
DZL4746L00S746	17.10	18	18.90	14	20	750	0.25	5	13.7	746
DZL4747L00S747	19.00	20	21.00	12.5	22	750	0.25	5	15.2	747

ELECTRICAL CHARACTERISTICS - Ta=25°C unless otherwise specified

Part Code	Zener Voltage Range V _{ZT} @ I _{ZT} (V)			Test Current I _{ZT} (mA)	Zener Impedance			Leakage Current		Marking Code
	Min.	Nom	Max.		Z _{ZT} @ I _{ZT} (Ω)	Z _{ZK} @I _{ZK}		Max. I _R (μA)	@ V _R (V)	
						(Ω)	mA			
DZL4748L00S748	20.90	22	23.10	11.5	23	750	0.25	5	16.7	748
DZL4749L00S749	22.80	24	25.20	10.5	25	750	0.25	5	18.2	749
DZL4750L00S750	25.65	27	28.35	9.5	35	750	0.25	5	20.6	750
DZL4751L00S751	28.50	30	31.50	8.5	40	1000	0.25	5	22.8	751
DZL4752L00S752	31.35	33	34.65	7.5	45	1000	0.25	5	25.1	752
DZL4753L00S753	34.20	36	37.80	7	50	1000	0.25	5	27.4	753
DZL4754L00S754	37.05	39	40.95	6.5	60	1500	0.25	5	29.7	754
DZL4755L00S755	40.85	43	45.15	6	70	1500	0.25	5	32.7	755
DZL4756L00S756	44.65	47	49.35	5.5	80	1500	0.25	5	35.8	756
DZL4757L00S757	48.45	51	53.55	5	95	1500	0.25	5	38.8	757
DZL4758L00S758	53.20	56	58.80	4.5	110	2000	0.25	5	42.6	758
DZL4759L00S759	58.90	62	65.10	4	125	2000	0.25	5	47.1	759
DZL4760L00S760	64.60	68	71.40	3.7	150	2000	0.25	5	51.7	760
DZL4761L00S761	71.25	75	78.75	3.3	175	2000	0.25	5	56.0	761
DZL4762L00S762	77.90	82	86.10	3	200	3000	0.25	5	62.2	762
DZL4763L00S763	86.45	91	95.55	2.8	250	3000	0.25	5	69.2	763
DZL4764L00S764	95.00	100	105.00	2.5	350	3000	0.25	5	76.0	764

CHARACTERISTICS CURVES- For Reference Only, Ta=25°C Unless Otherwise Specified.

Fig. 1
POWER TEMPERATURE
DERATING CURVE

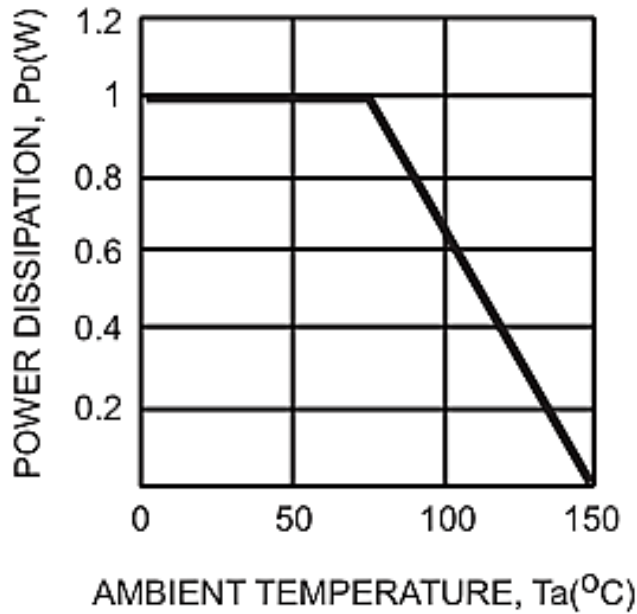
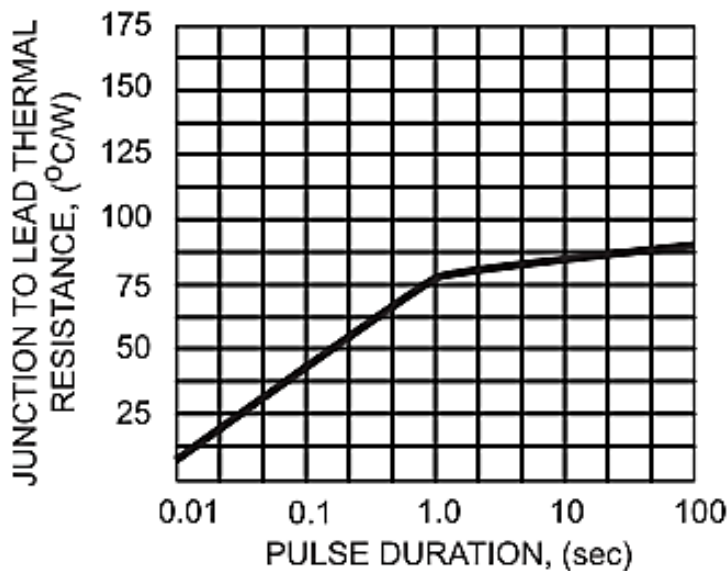
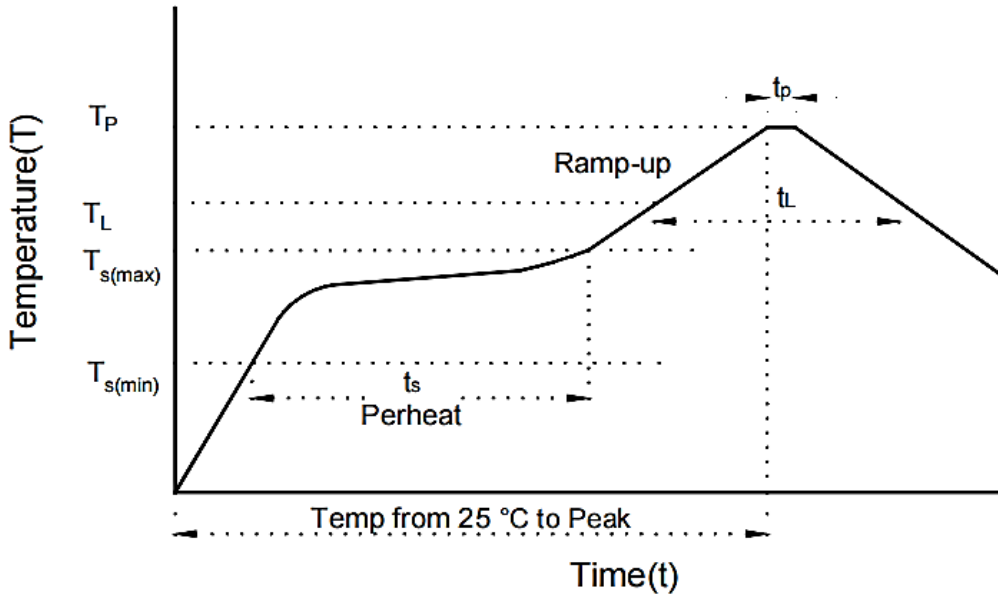

Fig. 2
TYPICAL THERMAL RESISTANCE
VERSUS LEAD LENGTH



SUGGESTED REFLOW PROFILE - For Reference Only



PROFILE FEATURE		PB-FREE ASSEMBLY
Average Ramp-up Rate (T_L Max to T_p)		3°C/second Max
Preheat	Temperature Min (T_s Min.)	150°C
	Temperature Max (T_s Max.)	200°C
	Time (t_s Min. to t_s Max.)	60 ~ 180 seconds
Time maintained above	Temperature (T_L)	217°C
	Time (t_L)	60 ~ 150 seconds
Peak/Classification Temperature (T_p)		260 °C
Time within 5°C of actual Peak Temperature (t_p)		10 seconds Max.
Ramp-down Rate		6 °C /Second Max.
Time 25 °C to Peak Temperature		8 Minutes Max.
Suggest reflow times		3 Times Max.

TAPE/REEL - Unit: mm, All Devices are packed in accordance with EIA standard RS-481-A and specifications

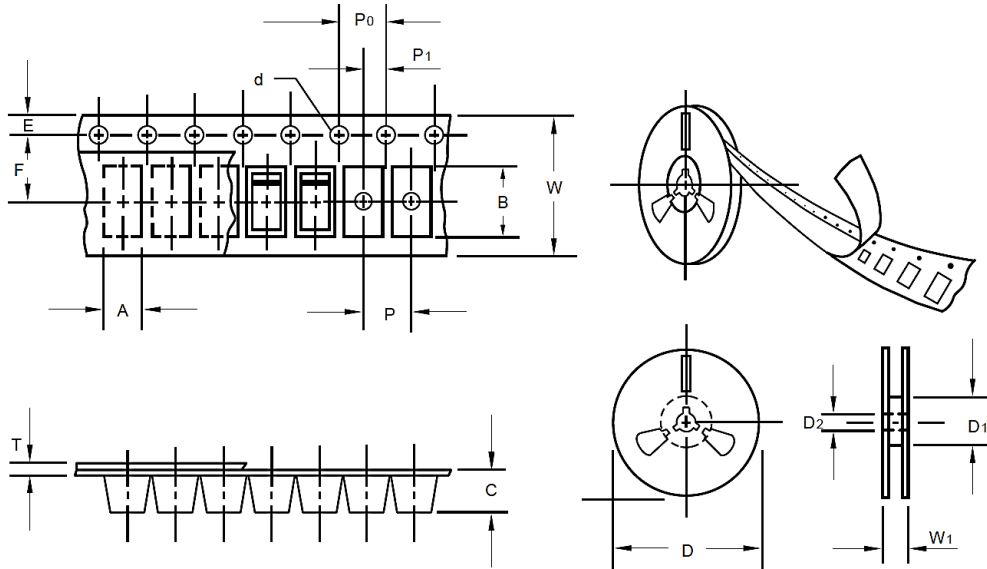

ITEM	SYMBOL	TOLERANCE	SOD-123FL
Carrier width	A	0.1	2.1
Carrier Length	B	0.1	4.0
Carrier Depth	C	0.1	1.60
Sprocket hole	d	0.05	1.55
7"Reel outside diameter	D	2	178
7"Reel inner diameter	D1	Min.	50.0
Feed hole diameter	D2	0.5	13
Sprocket hole position	E	0.1	1.75
Punch hole position	F	0.1	3.5
Punch hole pitch	P	0.1	4
Sprocket hole pitch	P0	0.1	4
Embossment center	P1	0.1	2
Overall tape thickness	T	0.1	0.25
Tape width	W	0.3	8.15
Reel width	W1	1	10.5
Qty. Per Reel (pcs)		3000	

IMPORTANT NOTES AND DISCLAIMER

1. **ROHS COMPLIANCE:** The levels of RoHS restricted materials in this product are below the maximum concentration values (also referred to as the threshold limits) permitted for such substances, or are used in an exempted application, in accordance with EU RoHS Directive (EU) 2015/863 EC (RoHS3). RoHS Test Report for this product can be obtained at Download Center.
2. **REACH COMPLIANCE:** REACH substances of high concern (SVHCs) information is available for this product. Since the European Chemical Agency (ECHA) has published notice of their intent to frequently revise the SVHC listing for the foreseeable future, REACH Test Report for this product can be obtained at Download Center.
3. All Product parametric performance is indicated in the Electrical Characteristics for the listed herein test conditions, unless otherwise noted. Product performance may not be indicated by the Electrical Characteristics if operated under different conditions.
4. NextGen Component, Inc (*NextGen*) reserves the right to make changes to this document and its products and specifications at any time without notice. Customers should obtain and confirm the latest product information and specifications before final design, purchase or use.
5. *NextGen* makes no warranty, representation or guarantee regarding the suitability of its products for any particular purpose, not does *NextGen* assume any liability for application assistance or customer product design.
6. *NextGen* does not warrant or accept any liability with products which are purchased or used for any unintended or unauthorized application. No license is granted by implication or otherwise under any intellectual property rights of NextGen.
7. *NextGen* products are not authorized for use as critical components in life support devices or systems without express written approval by *NextGen*.
8. *NextGen* requires that customers first obtain an RMA (Returned Merchandise Authorization) number prior to returning any products. Returns must be made within 30 days of the date of invoice, be in the original packaging, unused and like-new condition. At the time of quoting or purchasing, a product may say that it is Non-Cancelable/ Non-Returnable (NCNR). These products are not returnable and not refundable.