





|                                  |  |   |
|----------------------------------|--|---|
| SPECIFICATION SHEET NO.          | S1114 – DSK210L000S100   |   |
| ORIGINAL MFG/PART NO.            |  LGE Diodes/DSK210-L  |   |
| NEXTGEN PART CODE                | DSK210L000S100   | Indicate This Code For <a href="#">RFQ</a> /Order |
| DATE                             | Nov. 14, 2025  |   |
| REVISION                         | A3   | Updated With Most Recent Data                     |
| DESCRIPTION AND MAIN PARAMETRICS | <p>SMD Schottky Rectifiers 2 Pads, Case SOD-123FL, DSK2 L Series,<br/>           Forward Rectified Current (IAV) 2.0A Max.<br/>           Repetitive Peak Reverse Voltage (VRRM) 100V Max.<br/>           RMS Voltage (VRMS) 70V Max.<br/>           Operating Junction Temperature Range (TJ )-55°C ~+175°C<br/>           Package in Tape/Reel, 3000pcs/Reel<br/>           RoHS/RoHS III compliant, RoHS Annex III lead Exemption (Exempt per RoHS EU 2015/863) and Halogen Free (HF)</p> |   |
| CUSTOMER                         |  |   |
| CUSTOMER PART NUMBER             |  |   |
| CROSS REF. PART NUMBER           |  |   |
| MEMO                             |  |   |

|                               |   |   |
|-------------------------------|---|---|
| VENDOR APPROVE                |   |   |
| Issued/Checked/Approved       |  |   |
|                               |   |  |
| Effective Date: Nov. 14, 2025 |   |   |

|                  |  |
|------------------|--|
| CUSTOMER APPROVE |  |
|                  |  |
| Date:            |  |

## MAIN FEATURE

- Low Profile Package
- Ideal For Automated Placement
- Ultrafast Reverse Recovery Time
- Low Power Loss, High Efficiency
- Low Forward Voltage Drop.
- High Surge Capability
- High Temperature Soldering: 260°C/10 Seconds At Terminals
- Meet MSL 1 Requirement
- Component in accordance to WEEE 2002/96/EC
- Cross Competitors Parts and More.
- RoHS/RoHS III compliant, RoHS Annex III lead Exemption (Exempt per RoHS EU 2015/863) and Halogen Free (HF)



*Image shown is a representation only. Exact specifications should be obtained from the product dimension.*



## APPLICATION

- For SMD Application

## ELECTRICAL CHARACTERISTICS

- See Page 5 ~ Page 6.
- All Products Parameters are Subject To NextGen Components' Final Confirmation.

HOW TO ORDER

- Please Follow Up Part Code Guide And Indicate NextGen Part Code DSK210L000S100 For RFQ and Order.

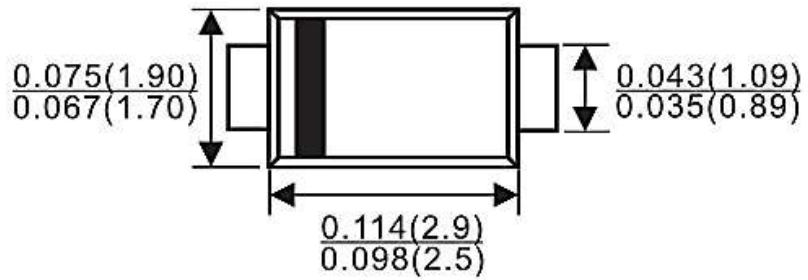
PART CODE GUIDE

**RFQ**  
Request For Quotation

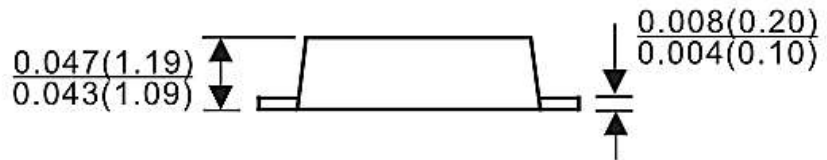
| CODE  | NAME   | KEY SPECIFICATION OPTION   |
|-------|--|--|
| DSK2  | Product Series Code                              | SMD Schottky Rectifier, Case SOD-123FL, Forward Rectified Current 2.0A<br><br>DSK2 L Series  |
| 10    | Max. Repetitive Peak<br><br>Reverse Voltage Code | 2: 20V Max. ; 3: 30V Max. ; 4: 40V Max.; 5: 50V Max.; 6: 60V Max.;<br>7: 70V Max.; 8: 80V Max.; 9: 90V Max. 10: 100V Max.; 15: 150V Max.;<br>20: 200V Max                        |
| L000S | Internal Control Code                            | Letter A~Z, a-z or Digits (0-9)  |
| 100   | Max. DC Blocking<br><br>Voltage Code             | 020: 20V Max. ; 030: 30V Max. ; 040: 40V Max.; 050: 50V Max.;<br>060: 60V Max.; 070: 70V Max.; 080: 80V Max.; 090: 90V Max.<br><br>100: 100V Max.; 150: 150V Max.; 200: 200V Max |
| XX    | Special/Custom<br><br>Parameters                 | Blank: N/A;<br><br>XX: Letter A~Z, a~z or digits (0~9) for Special/Custom Parameters   |

DIMENSION -- Unit: Inch (mm), Case SOD-123FL Outline

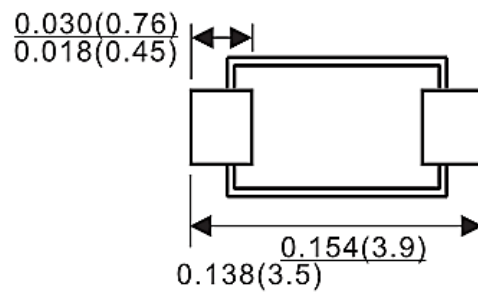
Top View



Side View



Bottom View



**MECHANICAL CHARACTERISTICS**

| CASE   | TERMINALS   | POLARITY                       | MOUNTING POSITION | WEIGHT     |
|--|---|--------------------------------|-------------------|------------|
| JEDEC SOD-123FL Molded Plastic Body Over Passivated Chip | Solder Plated, Solderable Per J-STD-002B And JESD22-B102D | Laser Band Denotes Cathode End | Any               | 0.017 Gram |

**MAX. RATINGS & ELECTRICAL CHARACTERISTICS**

- Ratings at 25 °C ambient temperature unless otherwise specified.

| PARAMETER                                 | CONDITION   | SYMBOL           | VALUE |      |      | UNITS |
|---|---|------------------|-------|------|------|-------|
|   |   |                  | MIN.  | TYP. | MAX. |       |
| Maximum Average Forward Rectified Current |   | I <sub>AV</sub>  |       |      | 2.0  | A     |
| Peak Forward Surge Current                | 8.3ms Single Half Sine-wave Superimposed On Rated Load (JEDEC Method) | I <sub>FSM</sub> |       |      | 40   | A     |
| Operating Junction Temperature Range      | @ V <sub>RRM</sub><br>20V/30V/40V/50V/60V                             | T <sub>J</sub>   | -55   |      | +150 | °C    |
|   | @ V <sub>RRM</sub><br>70V/80V/90V/100V/150V /200V                     |                  | -55   |      | +175 |       |
| Storage Temperature Range                 | @ V <sub>RRM</sub><br>20V/30V/40V/50V/60V                             | T <sub>STG</sub> | -55   |      | +150 | °C    |
|   | @ V <sub>RRM</sub><br>70V/80V/90V/100V/150V /200V                     |                  | -55   |      | +175 |       |

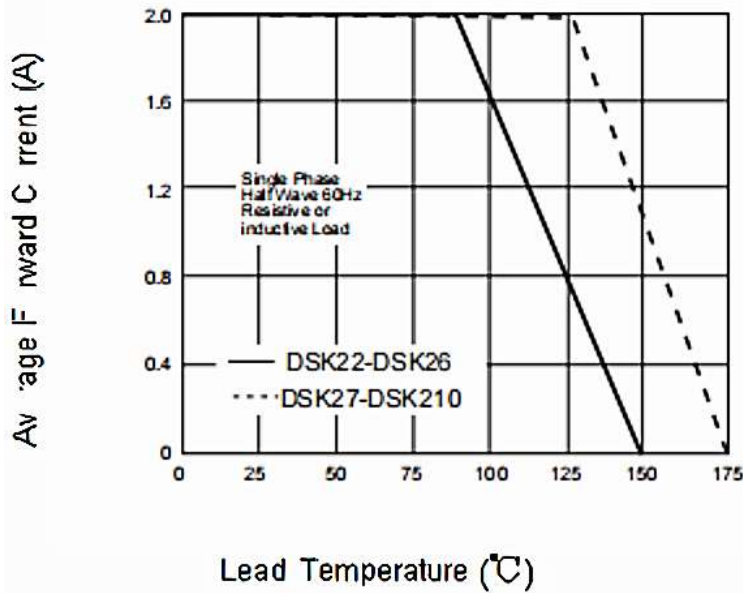
**ELECTRICAL CHARACTERISTICS - Ta=25°C unless otherwise specified**

| PART CODE             | Max.<br>Repetitive<br>Peak<br>Reverse<br>Voltage | Max.<br>RMS<br>Vol. | Max.<br>DC<br>Blocking<br>Voltage | Max.<br>Inst.<br>Forward<br>Voltage<br>@<br>2.0A | Max.<br>DC Reverse<br>Current<br>At Rated<br>DC<br>Blocking<br>Voltage |                  | Typical<br>Junction<br>Cap.<br>(Note 1) | Marking<br>List |                 |                |                |                |
|-----------------------|--|---------------------|-----------------------------------|--|--|------------------|---|-----------------|-----------------|----------------|----------------|----------------|
|                       |  |                     |                                   |  | @<br>25<br>°C  | @<br>100<br>°C   |   |                 |                 |                |                |                |
|                       |  |                     |                                   |  | V <sub>RRM</sub>   | V <sub>RMS</sub> |   |                 | V <sub>DC</sub> | V <sub>F</sub> | I <sub>R</sub> | C <sub>J</sub> |
|                       |  |                     |                                   |  | V  | V                |   |                 | V               | V              | mA             | pF             |
| DSK22L0000S020        | 20   | 14                  | 20                                | 0.55   | 0.5  | 10.0             | 220                                     | K22             |                 |                |                |                |
| DSK23L0000S030        | 30   | 21                  | 30                                | 0.55   | 0.5  | 10.0             | 220                                     | K23             |                 |                |                |                |
| DSK24L0000S040        | 40   | 28                  | 40                                | 0.55   | 0.5  | 10.0             | 220                                     | K24             |                 |                |                |                |
| DSK25L0000S050        | 50   | 35                  | 50                                | 0.70   | 0.5  | 10.0             | 80                                      | K25             |                 |                |                |                |
| DSK26L0000S060        | 60   | 42                  | 60                                | 0.70   | 0.5  | 10.0             | 80                                      | K26             |                 |                |                |                |
| DSK27L0000S070        | 70   | 49                  | 70                                | 0.85   | 0.5  | 5.0              | 80                                      | K27             |                 |                |                |                |
| DSK28L0000S080        | 80   | 56                  | 80                                | 0.85   | 0.5  | 5.0              | 80                                      | K28             |                 |                |                |                |
| DSK29L0000S090        | 90   | 63                  | 90                                | 0.85   | 0.5  | 5.0              | 80                                      | K29             |                 |                |                |                |
| <b>DSK210L000S100</b> | 100  | 70                  | 100                               | 0.85   | 0.5  | 5.0              | 80                                      | K210            |                 |                |                |                |
| DSK215L000S150        | 150  | 83                  | 150                               | 0.85   | 0.5  | 5.0              | 80                                      | K215            |                 |                |                |                |
| DSK220L000S200        | 200  | 90                  | 200                               | 0.85   | 0.5  | 5.0              | 80                                      | K220            |                 |                |                |                |

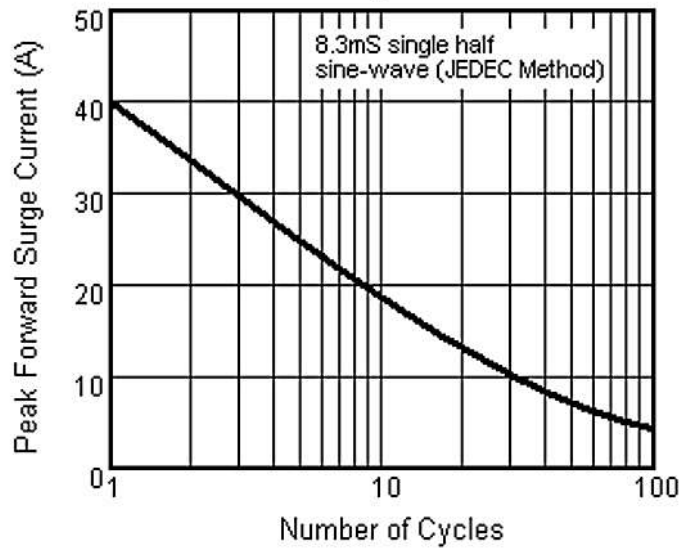
Note: 1. Measured at 1MHz And Applied Reverse Voltage Of 4.0V D.C

CHARACTERISTICS CURVES- For Reference Only, Ta=25°C Unless Otherwise Specified.

**Fig.1 Forward Current Derating Curve**

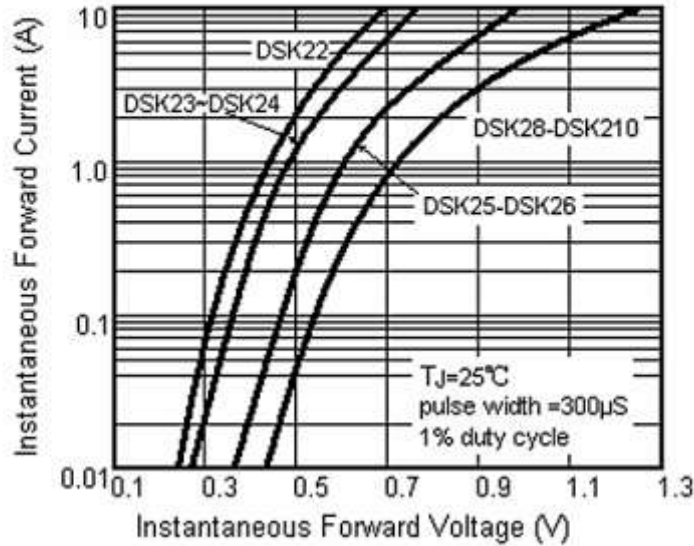


**Fig.2 Maximum Non-Repetitive Peak Forward Surge Current**

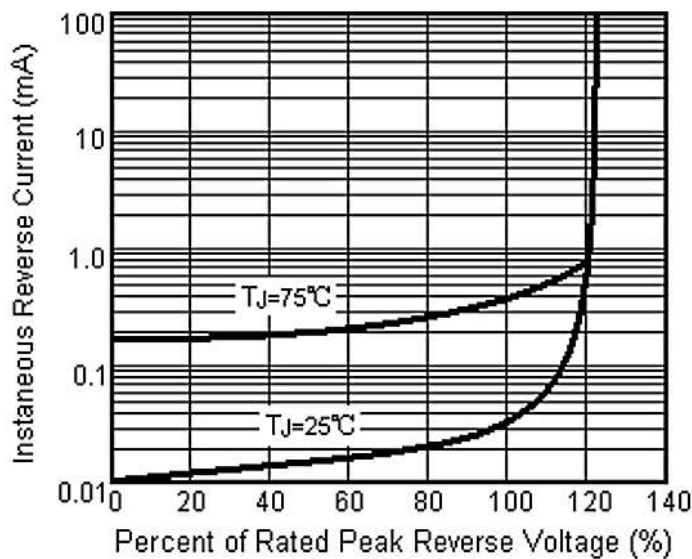


CHARACTERISTICS CURVES- For Reference Only, Ta=25°C Unless Otherwise Specified.

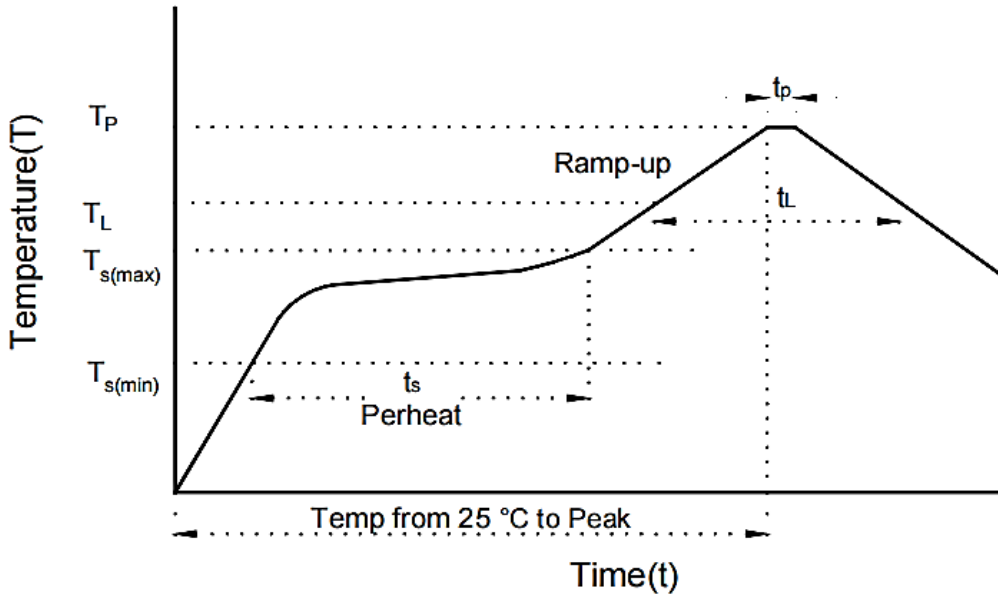
**Fig.3 Typical Instantaneous Forward Characteristics**



**Fig.4 Typical Reverse Characteristics**

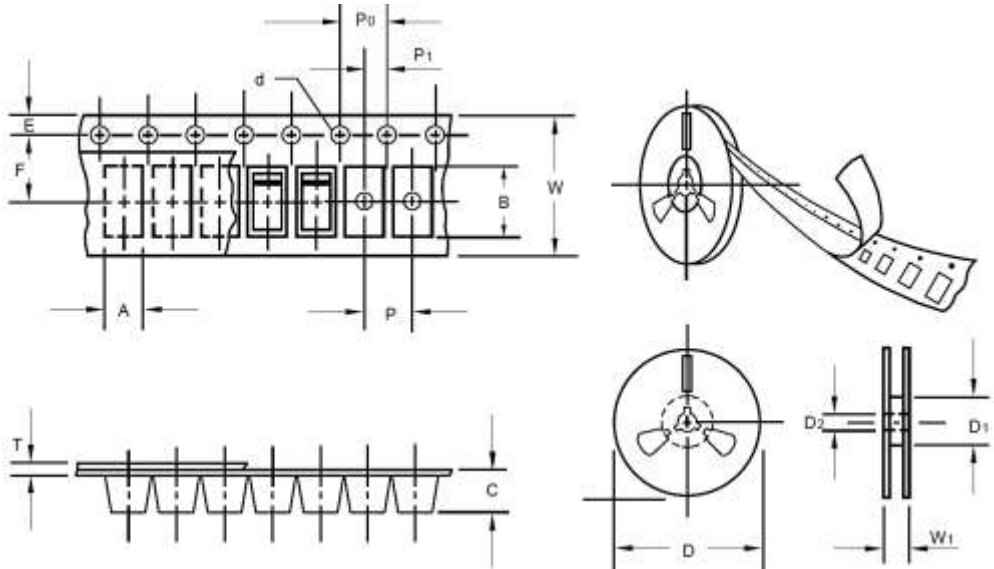


SUGGESTED REFLOW PROFILE - For Reference Only



| PROFILE FEATURE                                      |                                  | PB-FREE ASSEMBLY  |
|--|----------------------------------|-------------------|
| Average Ramp-up Rate ( $T_L$ Max to $T_p$ )          |                                  | 3°C/second Max    |
| Preheat  | Temperature Min ( $T_s$ Min.)    | 150°C             |
|  | Temperature Max ( $T_s$ Max.)    | 200°C             |
|  | Time ( $t_s$ Min. to $t_s$ Max.) | 60 ~ 180 seconds  |
| Time maintained above                                | Temperature ( $T_l$ )            | 217°C             |
|  | Time ( $t_l$ )                   | 60 ~ 150 seconds  |
| Peak/Classification Temperature ( $T_p$ )            |                                  | 260 °C            |
| Time within 5°C of actual Peak Temperature ( $t_p$ ) |                                  | 10 seconds Max.   |
| Ramp-down Rate                                       |                                  | 6 °C /Second Max. |
| Time 25 °C to Peak Temperature                       |                                  | 8 Minutes Max.    |
| Suggest reflow times                                 |                                  | 3 Times Max.      |

TAPE/REEL - Unit: mm, All Devices are packed in accordance with EIA standard RS-481-A and specifications



| ITEM                     | SYMBOL | TOLERANCE | SOD-123FL |
|--------------------------|--------|-----------|-----------|
| Carrier width            | A      | 0.1       | 2.1       |
| Carrier Length           | B      | 0.1       | 4.0       |
| Carrier Depth            | C      | 0.1       | 1.60      |
| Sprocket hole            | d      | 0.05      | 1.55      |
| 7" Reel outside diameter | D      | 2         | 178       |
| 7" Reel inner diameter   | D1     | Min.      | 50.0      |
| Feed hole diameter       | D2     | 0.5       | 13        |
| Sprocket hole position   | E      | 0.1       | 1.75      |
| Punch hole position      | F      | 0.1       | 3.5       |
| Punch hole pitch         | P      | 0.1       | 4         |
| Sprocket hole pitch      | P0     | 0.1       | 4         |
| Embossment center        | P1     | 0.1       | 2         |
| Overall tape thickness   | T      | 0.1       | 0.25      |
| Tape width               | W      | 0.3       | 8.15      |
| Reel width               | W1     | 1         | 10.5      |
| Qty. Per Reel (pcs)      |        | 3000      |           |

## IMPORTANT NOTES AND DISCLAIMER

1. **ROHS COMPLIANCE:** The levels of RoHS restricted materials in this product are below the maximum concentration values (also referred to as the threshold limits) permitted for such substances, or are used in an exempted application, in accordance with EU RoHS Directive (EU) 2015/863 EC (RoHS3). RoHS Test Report for this product can be obtained at Download Center.
2. **REACH COMPLIANCE:** REACH substances of high concern (SVHCs) information is available for this product. Since the European Chemical Agency (ECHA) has published notice of their intent to frequently revise the SVHC listing for the foreseeable future, REACH Test Report for this product can be obtained at Download Center.
3. All Product parametric performance is indicated in the Electrical Characteristics for the listed herein test conditions, unless otherwise noted. Product performance may not be indicated by the Electrical Characteristics if operated under different conditions.
4. NextGen Component, Inc (*NextGen*) reserves the right to make changes to this document and its products and specifications at any time without notice. Customers should obtain and confirm the latest product information and specifications before final design, purchase or use.
5. *NextGen* makes no warranty, representation or guarantee regarding the suitability of its products for any particular purpose, not does *NextGen* assume any liability for application assistance or customer product design.
6. *NextGen* does not warrant or accept any liability with products which are purchased or used for any unintended or unauthorized application. No license is granted by implication or otherwise under any intellectual property rights of NextGen.
7. *NextGen* products are not authorized for use as critical components in life support devices or systems without express written approval by *NextGen*.
8. *NextGen* requires that customers first obtain an RMA (Returned Merchandise Authorization) number prior to returning any products. Returns must be made within 30 days of the date of invoice, be in the original packaging, unused and like-new condition. At the time of quoting or purchasing, a product may say that it is Non-Cancelable/ Non-Returnable (NCNR). These products are not returnable and not refundable.