





SPECIFICATION SHEET NO.	S1114 – DSK25L0000S050	
ORIGINAL MFG/PART NO.	 LGE Diodes/DSK25-L	
NEXTGEN PART CODE	DSK25L0000S050	Indicate This Code For <a href="#">RFQ</a> /Order
DATE	Nov. 14, 2025	
REVISION	A3	Updated With Most Recent Data
DESCRIPTION AND MAIN PARAMETRICS	<p>SMD Schottky Rectifiers 2 Pads, Case SOD-123FL, DSK2 L Series,            Forward Rectified Current (IAV) 2.0A Max.            Repetitive Peak Reverse Voltage (VRRM) 50V Max.            RMS Voltage (VRMS) 35V Max.            Operating Junction Temperature Range (TJ )-55°C ~+150°C            Package in Tape/Reel, 3000pcs/Reel            RoHS/RoHS III compliant, RoHS Annex III lead Exemption (Exempt per RoHS EU 2015/863) and Halogen Free (HF)</p>	
CUSTOMER		
CUSTOMER PART NUMBER		
CROSS REF. PART NUMBER		
MEMO		

VENDOR APPROVE		
Issued/Checked/Approved		
		
Effective Date: Nov. 14, 2025		

CUSTOMER APPROVE	
Date:	

## MAIN FEATURE

- Low Profile Package
- Ideal For Automated Placement
- Ultrafast Reverse Recovery Time
- Low Power Loss, High Efficiency
- Low Forward Voltage Drop.
- High Surge Capability
- High Temperature Soldering: 260°C/10 Seconds At Terminals
- Meet MSL 1 Requirement
- Component in accordance to WEEE 2002/96/EC
- Cross Competitors Parts and More.
- RoHS/RoHS III compliant, RoHS Annex III lead Exemption (Exempt per RoHS EU 2015/863) and Halogen Free (HF)



*Image shown is a representation only. Exact specifications should be obtained from the product dimension.*



## APPLICATION

- For SMD Application

## ELECTRICAL CHARACTERISTICS

- See Page 5 ~ Page 6.
- All Products Parameters are Subject To NextGen Components' Final Confirmation.

HOW TO ORDER

- Please Follow Up Part Code Guide And Indicate NextGen Part Code [DSK25L0000S050](#) For RFQ and Order.

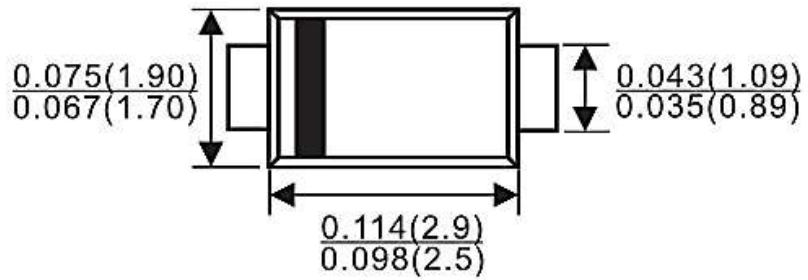
PART CODE GUIDE

**RFQ**  
Request For Quotation

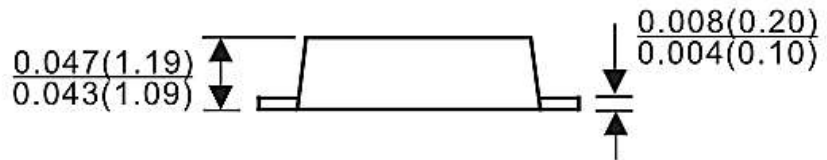
CODE	NAME	KEY SPECIFICATION OPTION
DSK2	Product Series Code	SMD Schottky Rectifier, Case SOD-123FL, Forward Rectified Current 2.0A  DSK2 L Series
5	Max. Repetitive Peak  Reverse Voltage Code	2: 20V Max. ; 3: 30V Max. ; 4: 40V Max.; 5: 50V Max.; 6: 60V Max.; 7: 70V Max.; 8: 80V Max.; 9: 90V Max. 10: 100V Max.; 15: 150V Max.; 20: 200V Max
L0000S	Internal Control Code	Letter A~Z, a-z or Digits (0-9)
050	Max. DC Blocking  Voltage Code	020: 20V Max. ; 030: 30V Max. ; 040: 40V Max.; 050: 50V Max.; 060: 60V Max.; 070: 70V Max.; 080: 80V Max.; 090: 90V Max.  100: 100V Max.; 150: 150V Max.; 200: 200V Max
XX	Special/Custom  Parameters	Blank: N/A;  XX: Letter A~Z, a~z or digits (0~9) for Special/Custom Parameters

DIMENSION -- Unit: Inch (mm), Case SOD-123FL Outline

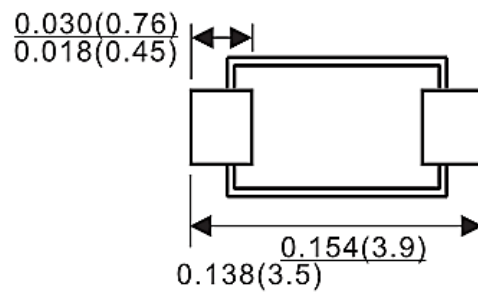
Top View



Side View



Bottom View



**MECHANICAL CHARACTERISTICS**

CASE	TERMINALS	POLARITY	MOUNTING POSITION	WEIGHT
JEDEC SOD-123FL Molded Plastic Body Over Passivated Chip	Solder Plated, Solderable Per J-STD-002B And JESD22-B102D	Laser Band Denotes Cathode End	Any	0.017 Gram

**MAX. RATINGS & ELECTRICAL CHARACTERISTICS**

- Ratings at 25 °C ambient temperature unless otherwise specified.

PARAMETER	CONDITION	SYMBOL	VALUE			UNITS
			MIN.	TYP.	MAX.	
Maximum Average Forward Rectified Current		I <sub>AV</sub>			2.0	A
Peak Forward Surge Current	8.3ms Single Half Sine-wave Superimposed On Rated Load (JEDEC Method)	I <sub>FSM</sub>			40	A
Operating Junction Temperature Range	@ V <sub>RRM</sub> 20V/30V/40V/50V/60V	T <sub>J</sub>	-55		+150	°C
	@ V <sub>RRM</sub> 70V/80V/90V/100V/150V /200V		-55		+175	
Storage Temperature Range	@ V <sub>RRM</sub> 20V/30V/40V/50V/60V	T <sub>STG</sub>	-55		+150	°C
	@ V <sub>RRM</sub> 70V/80V/90V/100V/150V /200V		-55		+175	

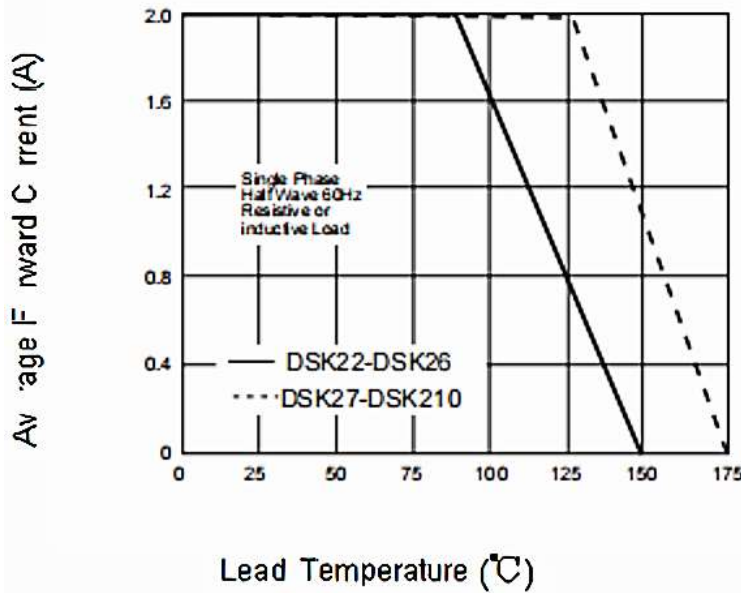
ELECTRICAL CHARACTERISTICS - Ta=25°C unless otherwise specified

PART CODE	Max. Repetitive Peak Reverse Voltage	Max. RMS Vol.	Max. DC Blocking Voltage	Max. Inst. Forward Voltage @ 2.0A	Max. DC Reverse Current At Rated DC Blocking Voltage		Typical Junction Cap. (Note 1)	Marking List				
					@ 25 °C	@ 100 °C						
					V <sub>RRM</sub>	V <sub>RMS</sub>			V <sub>DC</sub>	V <sub>F</sub>	I <sub>R</sub>	C <sub>J</sub>
					V	V			V	V	mA	pF
DSK22L0000S020	20	14	20	0.55	0.5	10.0	220	K22				
DSK23L0000S030	30	21	30	0.55	0.5	10.0	220	K23				
DSK24L0000S040	40	28	40	0.55	0.5	10.0	220	K24				
<b>DSK25L0000S050</b>	50	35	50	0.70	0.5	10.0	80	K25				
DSK26L0000S060	60	42	60	0.70	0.5	10.0	80	K26				
DSK27L0000S070	70	49	70	0.85	0.5	5.0	80	K27				
DSK28L0000S080	80	56	80	0.85	0.5	5.0	80	K28				
DSK29L0000S090	90	63	90	0.85	0.5	5.0	80	K29				
DSK210L0000S100	100	70	100	0.85	0.5	5.0	80	K210				
DSK215L0000S150	150	83	150	0.85	0.5	5.0	80	K215				
DSK220L0000S200	200	90	200	0.85	0.5	5.0	80	K220				

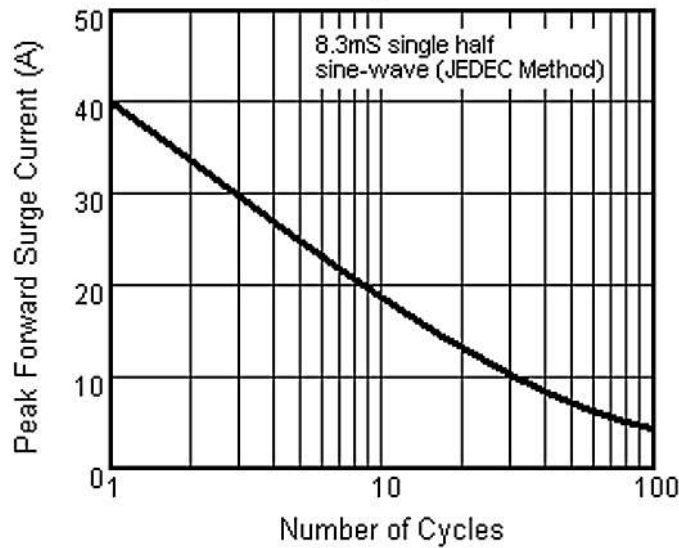
Note: 1. Measured at 1MHz And Applied Reverse Voltage Of 4.0V D.C

CHARACTERISTICS CURVES- For Reference Only, Ta=25°C Unless Otherwise Specified.

**Fig.1 Forward Current Derating Curve**

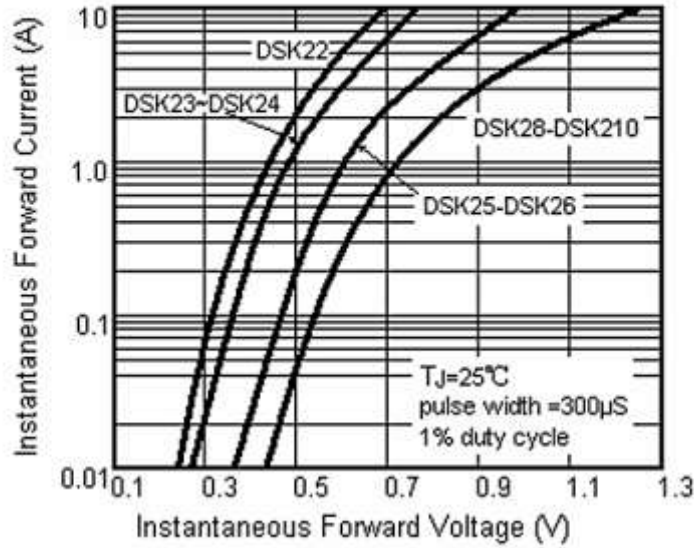


**Fig.2 Maximum Non-Repetitive Peak Forward Surge Current**

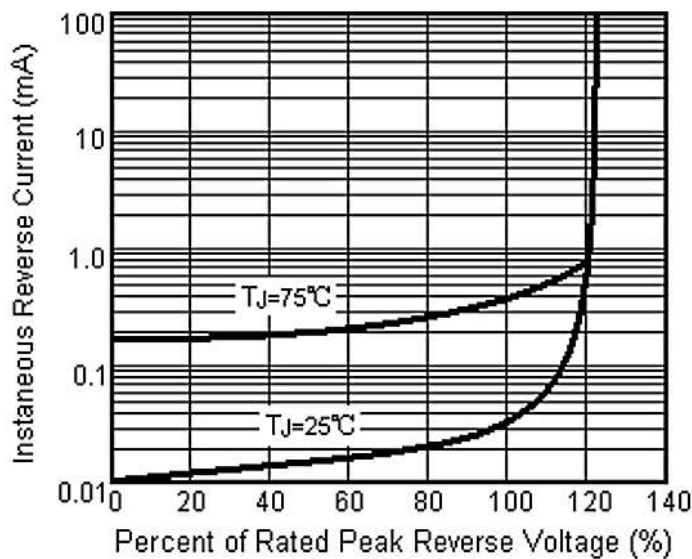


CHARACTERISTICS CURVES- For Reference Only, Ta=25°C Unless Otherwise Specified.

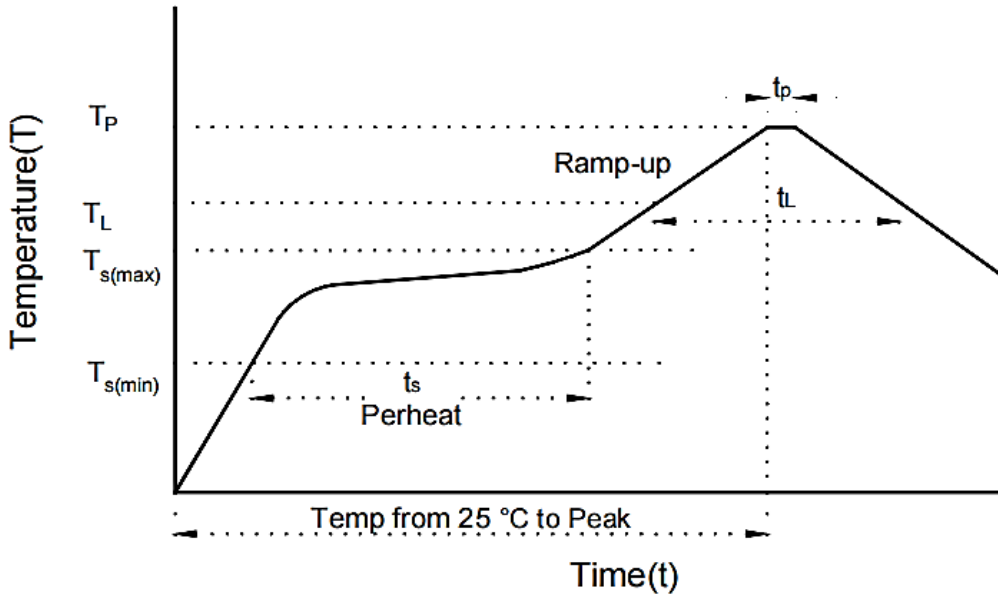
**Fig.3 Typical Instantaneous Forward Characteristics**



**Fig.4 Typical Reverse Characteristics**

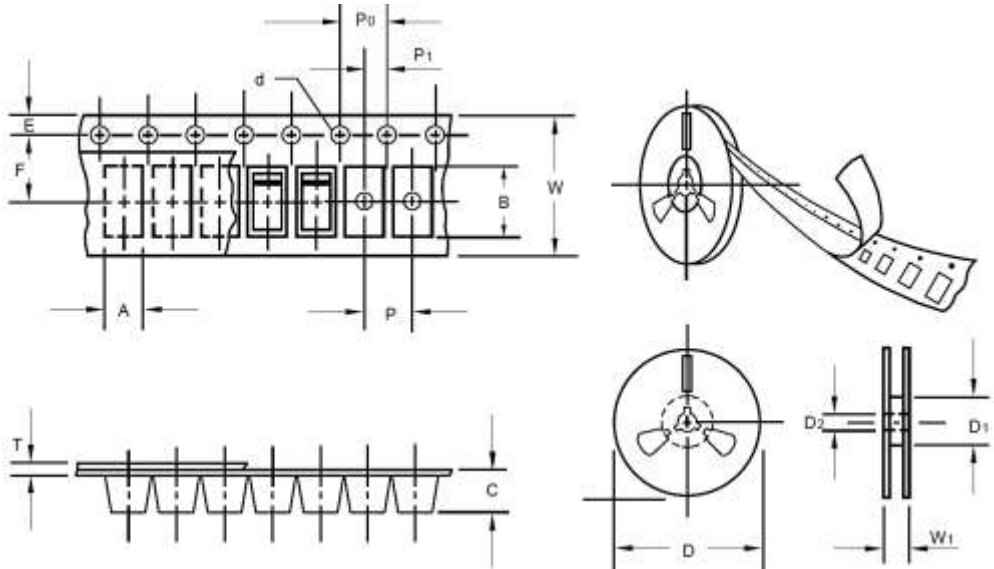


SUGGESTED REFLOW PROFILE - For Reference Only



PROFILE FEATURE		PB-FREE ASSEMBLY
Average Ramp-up Rate ( $T_L$ Max to $T_p$ )		3°C/second Max
Preheat	Temperature Min ( $T_s$ Min.)	150°C
	Temperature Max ( $T_s$ Max.)	200°C
	Time ( $t_s$ Min. to $t_s$ Max.)	60 ~ 180 seconds
Time maintained above	Temperature ( $T_l$ )	217°C
	Time ( $t_l$ )	60 ~ 150 seconds
Peak/Classification Temperature ( $T_p$ )		260 °C
Time within 5°C of actual Peak Temperature ( $t_p$ )		10 seconds Max.
Ramp-down Rate		6 °C /Second Max.
Time 25 °C to Peak Temperature		8 Minutes Max.
Suggest reflow times		3 Times Max.

TAPE/REEL - Unit: mm, All Devices are packed in accordance with EIA standard RS-481-A and specifications



ITEM	SYMBOL	TOLERANCE	SOD-123FL
Carrier width	A	0.1	2.1
Carrier Length	B	0.1	4.0
Carrier Depth	C	0.1	1.60
Sprocket hole	d	0.05	1.55
7" Reel outside diameter	D	2	178
7" Reel inner diameter	D1	Min.	50.0
Feed hole diameter	D2	0.5	13
Sprocket hole position	E	0.1	1.75
Punch hole position	F	0.1	3.5
Punch hole pitch	P	0.1	4
Sprocket hole pitch	P0	0.1	4
Embossment center	P1	0.1	2
Overall tape thickness	T	0.1	0.25
Tape width	W	0.3	8.15
Reel width	W1	1	10.5
Qty. Per Reel (pcs)		3000	

## IMPORTANT NOTES AND DISCLAIMER

1. **ROHS COMPLIANCE:** The levels of RoHS restricted materials in this product are below the maximum concentration values (also referred to as the threshold limits) permitted for such substances, or are used in an exempted application, in accordance with EU RoHS Directive (EU) 2015/863 EC (RoHS3). RoHS Test Report for this product can be obtained at Download Center.
2. **REACH COMPLIANCE:** REACH substances of high concern (SVHCs) information is available for this product. Since the European Chemical Agency (ECHA) has published notice of their intent to frequently revise the SVHC listing for the foreseeable future, REACH Test Report for this product can be obtained at Download Center.
3. All Product parametric performance is indicated in the Electrical Characteristics for the listed herein test conditions, unless otherwise noted. Product performance may not be indicated by the Electrical Characteristics if operated under different conditions.
4. NextGen Component, Inc (*NextGen*) reserves the right to make changes to this document and its products and specifications at any time without notice. Customers should obtain and confirm the latest product information and specifications before final design, purchase or use.
5. *NextGen* makes no warranty, representation or guarantee regarding the suitability of its products for any particular purpose, not does *NextGen* assume any liability for application assistance or customer product design.
6. *NextGen* does not warrant or accept any liability with products which are purchased or used for any unintended or unauthorized application. No license is granted by implication or otherwise under any intellectual property rights of NextGen.
7. *NextGen* products are not authorized for use as critical components in life support devices or systems without express written approval by *NextGen*.
8. *NextGen* requires that customers first obtain an RMA (Returned Merchandise Authorization) number prior to returning any products. Returns must be made within 30 days of the date of invoice, be in the original packaging, unused and like-new condition. At the time of quoting or purchasing, a product may say that it is Non-Cancelable/ Non-Returnable (NCNR). These products are not returnable and not refundable.