

Multilayer Ceramic Chip Capacitors for General Purpose
C0402COG150J500NTB (0402,COG,15 pF,DC 50 V)

1. Scope

This specification applies to Multilayer Ceramic Chip Capacitors (MLCC), specifically intended for general consumer electronics such as: smartphones/smartwatches, laptops, home appliances, wireless communication devices, among others.

2. Part Number System

C	0402	COG	150	J	500	N	T	B
①	②	③	④	⑤	⑥	⑦	⑧	⑨
Series Code	Size Code	Temperature Characteristics	Nominal Capacitance	Capacitance Tolerance	Rated Voltage	Termination Type	Packaging Code	Thickness Code

① **Series Code** C-Multilayer Ceramic Chip Capacitors for General Purpose

② **Size Code** (Unit: mm)

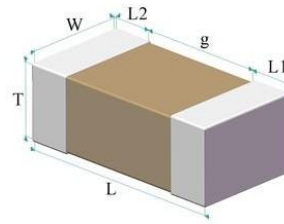

Fig.1 Structure & Dimension

Size Code	L	W	L1,L2	g	T	⑨ Thickness Code
0402	1.00 ± 0.05	0.50 ± 0.05	0.15-0.35	0.30 min	0.50 ± 0.05	B

③ Temperature Characteristics

Temperature Characteristics	Operating Temp. Range	Temperature Characteristics		
		Temp. coeff. or Cap. Change	Temp. Range	Ref. Temp.
COG	-55 °C-125 °C	0±30 ppm/°C	25 °C-125 °C	25 °C

④ Nominal Capacitance

Code	Nominal Capacitance
150	15 pF

⑤ Capacitance Tolerance

Code	Capacitance Tolerance
J	±5%

⑥ Rated Voltage

Code	Voltage Values
500	DC 50V

⑦ Termination Type

Code	Terminal Electrodes	Plating Material
N	Cu	Ni/Sn

⑧ Packaging Code

Code	Square Hole Spacing	Disc Size	Carrier Tape	QTY (Kpcs)
T	2 mm	7"	Paper	10

3. Technical Specifications and Test Methods

1. Operating Environment

Temp. Characteristics	Temp. Range	Relative Humidity	Atmospheric Pressure
C0G	-55 °C-125 °C	≤95% (25 °C)	86 kPa-106 kPa

3.2 Reliability Test Specifications and Methods

Unless otherwise specified, the test methods in Table 1 are based on: GB/T 21041 and GB/T 21042 (IDT IEC 6038)

Table 1: Specifications and Methods

No.	Item	Specification	Test Method
1	Appearance	No obvious defects on ceramic body and termination.	Visual examination under a microscope
2	Size Code	See Fig.1 and ② Size Code	Measuring by gages which precision is not less than 0.01 mm.
3	Capacitance	Within the specified tolerance	Measurement Temperature 18 °C-28 °C Relative Humidity ≤ 80% RH
4	Q	C ≥ 30 pF, Q ≥ 1000 C < 30 pF, Q ≥ 400 + 20 C C: Nominal Capacitance (pF)	Measurement Frequency C ≤ 1nF, f = 1.0 ± 0.1 MHz C > 1 nF, f = 1.0 ± 0.1 KHz Measurement Voltage 1.0 ± 0.2 Vrms
5	Insulation Resistance (IR)	≥ 10,000 Mfi or 500 fi·F, (Whichever is smaller)	Measurement Temperature 18 °C-28 °C Relative Humidity ≤ 80% RH Measurement Voltage Rated Voltage Charging Time 1 min Charge/discharge current ≤ 50 mA
6	Voltage proof	No defects or abnormalities.	Test Voltage ≥ 3 × U _R Applied Time t = 1 -5 s Charge/discharge current ≤ 50 mA
7	Temperature characteristic of capacitance	C0G: αc ≤ ± 30 ppm/°C (125 °C) ; -72 ≤ αc ≤ + 30 ppm/°C (-55 °C)	Pre-drying 16-24 hours Measure the capacitance separately in 25 °C, θ1, 25 °C, θ2, 25 °C, should satisfied related Temperature Coefficient of Capacitance (αc) . C0G θ1 = -55 °C, θ2 = 125 °C T.C. Measurement Voltage 1.0 ± 0.2 Vrms
8	Resistance to soldering heat	Appearance No visible damage and terminations uncovered shall be less than 25%. Cap. Change ΔC/C ≤ ± 2.5% or ± 0.25 pF, (Whichever is larger) IR Initial specification Q Initial specification Voltage proof No defects or abnormalities.	Pre-heating 120 °C-150 °C, Time: 60 s Test Method Solder bath Solder alloy Sn-Ag-Cu (Lead Free Solder) Temperature (270 ± 5) °C Duration of immersion (10±1) s Depth of immersion 10 mm Post-treatment Let sit for (24 ± 2) h at room temperature, then measure.

Table 1: Specifications and Methods

No.	Item	Specification	Test Method															
9	Solderability	Appearance 95% of the terminations is to be soldered evenly and continuously	Pre-heating 80 °C-120 °C, Time: 10-30 s Test Method Solder bath Flux Solution of rosin ethanol Solder alloy Sn-Ag-Cu (Lead Free Solder) Temperature (245 ± 5) °C Duration of immersion (2.0 ± 0.5) s Depth of immersion 10 mm															
10	Substrate bending test	Appearance No defects or abnormalities Cap. Change $\Delta C/C \leq \pm 5\%$ or ± 0.5 pF, (Whichever is larger)	Mounting method Solder the capacitor to the test substrate as shown in Fig 2 Pressurization Method Shown in Fig 3 Flexure 1 mm Holding Time (5 ± 1) s then measure the capacitance  															
11	Adhesive strength of termination	Appearance No defects or abnormalities	Mounting method Solder the capacitor to the test substrate and apply the normal force F indicated in Fig. 4 Holding Time $t = (10 \pm 1)$ s Pushing force 0402: F = 5 N 															
12	Vibration	Appearance No defects or abnormalities Cap. Change Initial specification IR Initial specification Q Initial specification	Mounting method Solder the capacitor to the test substrate Amplitude 1.5 mm Kind of Vibration A simple harmonic motion Frequency 10 Hz-55 Hz-10 Hz Vibration Time 1 min Repeat this for 2 hours each in 3 perpendicular directions X, Y, Z, total 6 hours.															
13	Rapid change of temperature	Appearance No defects or abnormalities Cap. Change $\Delta C/C \leq \pm 2.5\%$ or ± 0.25 pF, (Whichever is larger) IR Initial specification Q Initial specification Voltage proof No defects or abnormalities.	Mounting method Solder the capacitor to the test substrate The number of cycles 5 cycles Temperature Step <table border="1" data-bbox="1299 1260 1657 1444"> <thead> <tr> <th>Step</th> <th>Temp.(°C)</th> <th>Time (min)</th> </tr> </thead> <tbody> <tr> <td>1</td> <td>-55</td> <td>30 ± 3</td> </tr> <tr> <td>2</td> <td>25</td> <td>2-5</td> </tr> <tr> <td>3</td> <td>125</td> <td>30 ± 3</td> </tr> <tr> <td>4</td> <td>25</td> <td>2-5</td> </tr> </tbody> </table> Post-treatment Let sit for (24 ± 2) h at room temperature, then measure.	Step	Temp.(°C)	Time (min)	1	-55	30 ± 3	2	25	2-5	3	125	30 ± 3	4	25	2-5
Step	Temp.(°C)	Time (min)																
1	-55	30 ± 3																
2	25	2-5																
3	125	30 ± 3																
4	25	2-5																

Table 1: Specifications and Methods

No.	Item	Specification	Test Method
14	Damp heat, steady state	Appearance No defects or abnormalities Cap. Change $\Delta C/C \leq \pm 7.5\%$ or 0.75 pF, (Whichever is larger) IR ≥ 500 Mfi or 25 fi·F, (Whichever is smaller) Q $C \geq 30$ pF, $Q \geq 200$ $C < 30$ pF, $Q \geq 100 + 10 C/3$ C: Nominal Capacitance (pF)	Mounting method Solder the capacitor to the test substrate Test Temperature $(40 \pm 2) ^\circ\text{C}$ Test Humidity 90%–95% RH Test Time (500 ± 12) h Post-treatment Let sit for (24 ± 2) h at room temperature, then measure.
15	High temperature high humidity (steady)	Appearance No defects or abnormalities Cap. Change $\Delta C/C \leq \pm 7.5\%$ or 0.75 pF, (Whichever is larger) IR ≥ 500 Mfi or 25 fi·F, (Whichever is smaller) Q $C \geq 30$ pF, $Q \geq 200$ $C < 30$ pF, $Q \geq 100 + 10 C/3$ C: Nominal Capacitance (pF)	Mounting method Solder the capacitor to the test substrate Test Temperature $(40 \pm 2) ^\circ\text{C}$ Test Humidity 90%–95% RH Test Voltage $1.0 \times U_R$ Test Time (500 ± 12) h Charge/discharge curren ≤ 50 mA Post-treatment Let sit for (24 ± 2) h at room temperature, then measure.
16	Endurance	Appearance No defects or abnormalities Cap. Change $\Delta C/C \leq \pm 2\%$ or ± 0.2 pF, (Whichever is larger) IR ≥ 1000 Mfi or 50 fi·F, (Whichever is smaller) Q $C \geq 30$ pF, $Q \geq 350$ $10 \text{ pF} < C < 30 \text{ pF}$, $Q \geq 275 + 5 C/2$ $C \leq 10$ pF, $Q \geq 200 + 10 C$ C: Nominal Capacitance (pF)	Mounting method Solder the capacitor to the test substrate Test Temperature $125 ^\circ\text{C} \pm 3 ^\circ\text{C}$ Test Voltage $2.0 \times U_R$ Test Time (1000 ± 12) h Charge/discharge curren ≤ 50 mA Post-treatment Let sit for (24 ± 2) h at room temperature, then measure.

4. Packaging, Shipment and storage

4.1 Packaging

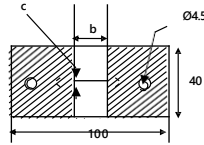
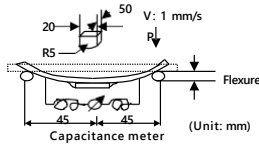
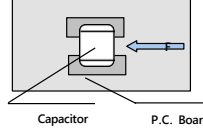
4.1.1 packaging type

Reel Packaging (standard carrier tape disc packaging), single disc smallest package see ⑧ Packaging Code

First packaging: Each multi-disc material is packed into a box.

The second packaging: the first packaged packaging box is loaded into the paper packaging box, and the remaining space in the box is filled with light auxiliary materials.

The above packaging forms can also be packaged according to user needs.

4.1.2 Carrier Tape size

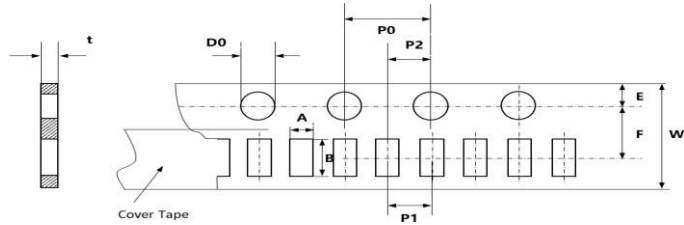

Fig. 5-1 0402 (Paper tape/ 2 mm pitch)

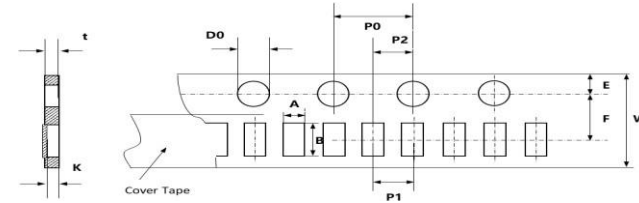

Fig. 5-2 0201 (Paper tape/ 2 mm pitch)

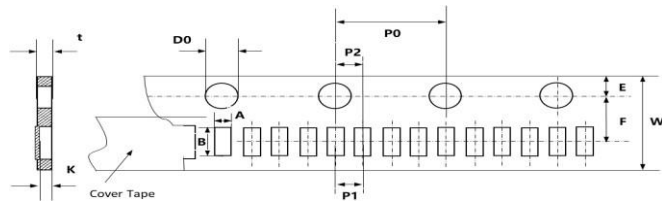

Fig. 5-3 0201 (Paper tape/ 1 mm pitch)

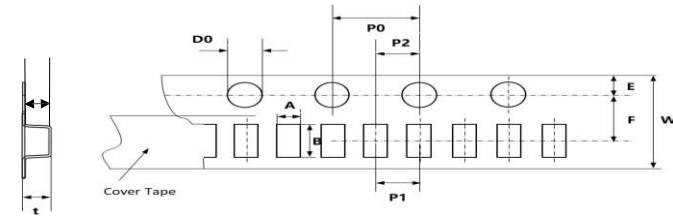

Fig. 5-4 A8A4/0105 (Plastic tape/ 1 mm pitch)

Table 2-1: Carrier size (Size Code:A8A4,0105,0201,0402)

(Unit:mm)

Size Code	Thickness code	Carrier Tape Type	Packaging Code	A	B	F	P1	E	D0	P2	K	W	P0	t
A8A4	1	Plastic	P	0.145 ± 0.007	0.270 ± 0.007	1.80 ± 0.05	1.00 ± 0.05	0.90 ± 0.1	0.80 ± 0.05	1.00 ± 0.05	0.145 ± 0.007	4.00 ± 0.10	2.00 ± 0.1	0.5 max
0105	Z	Paper	T	0.24 ± 0.02	0.45 ± 0.02	3.50 ± 0.05	2.00 ± 0.05	1.75 ± 0.10	1.55 ± 0.05	2.00 ± 0.05	0.24 ± 0.02	8.00 ± 0.10	4.00 ± 0.10	0.5 max
0105	Z	Paper	H	0.24 ± 0.02	0.45 ± 0.02	3.50 ± 0.05	2.00 ± 0.05	1.75 ± 0.10	1.55 ± 0.05	2.00 ± 0.05	0.24 ± 0.02	8.00 ± 0.10	4.00 ± 0.10	0.5 max
0105	Z	Plastic	P	0.24 ± 0.02	0.45 ± 0.02	1.80 ± 0.05	1.00 ± 0.05	0.90 ± 0.10	0.80 ± 0.05	1.00 ± 0.05	0.24 ± 0.02	4.00 ± 0.10	2.00 ± 0.10	0.5 max
0201	A	Paper	T	0.38 ± 0.03	0.68 ± 0.03	3.50 ± 0.05	2.00 ± 0.05	1.75 ± 0.10	1.55 ± 0.05	2.00 ± 0.05	0.36 ± 0.02	8.00 ± 0.10	4.00 ± 0.10	0.5 max
0201	A	Paper	J	0.38 ± 0.03	0.68 ± 0.03	3.50 ± 0.05	2.00 ± 0.05	1.75 ± 0.10	1.55 ± 0.05	2.00 ± 0.05	0.36 ± 0.02	8.00 ± 0.10	4.00 ± 0.10	0.5 max
0201	A	Paper	D	0.38 ± 0.03	0.68 ± 0.03	3.50 ± 0.05	1.00 ± 0.05	1.75 ± 0.10	1.55 ± 0.05	1.00 ± 0.05	0.36 ± 0.02	8.00 ± 0.10	4.00 ± 0.10	0.5 max
0201	A	Paper	A	0.38 ± 0.03	0.68 ± 0.03	3.50 ± 0.05	1.00 ± 0.05	1.75 ± 0.10	1.55 ± 0.05	1.00 ± 0.05	0.36 ± 0.02	8.00 ± 0.10	4.00 ± 0.10	0.5 max
0201	A	Paper	M	0.38 ± 0.03	0.68 ± 0.03	3.50 ± 0.05	2.00 ± 0.05	1.75 ± 0.10	1.55 ± 0.05	2.00 ± 0.05	0.36 ± 0.02	8.00 ± 0.10	4.00 ± 0.10	0.5 max
0201	A	Paper	H	0.38 ± 0.03	0.68 ± 0.03	3.50 ± 0.05	2.00 ± 0.05	1.75 ± 0.10	1.55 ± 0.05	2.00 ± 0.05	0.36 ± 0.02	8.00 ± 0.10	4.00 ± 0.10	0.5 max
0201	A	Paper	L	0.38 ± 0.03	0.68 ± 0.03	3.50 ± 0.05	1.00 ± 0.05	1.75 ± 0.10	1.55 ± 0.05	1.00 ± 0.05	0.36 ± 0.02	8.00 ± 0.10	4.00 ± 0.10	0.5 max
0201	J	Paper	T	0.40 ± 0.04	0.70 ± 0.04	3.50 ± 0.05	2.00 ± 0.05	1.75 ± 0.10	1.55 ± 0.05	2.00 ± 0.05	0.38 ± 0.04	8.00 ± 0.10	4.00 ± 0.10	0.5 max
0201	J	Paper	J	0.40 ± 0.04	0.70 ± 0.04	3.50 ± 0.05	2.00 ± 0.05	1.75 ± 0.10	1.55 ± 0.05	2.00 ± 0.05	0.38 ± 0.04	8.00 ± 0.10	4.00 ± 0.10	0.5 max

Table 2-1: Carrier size (Size Code:A8A4,0105,0201,0402)

(Unit:mm)

Size Code	Thickness code	Carrier Tape Type	Packaging Code	A	B	F	P1	E	D0	P2	K	W	P0	t
0201	J	Paper	D	0.40 ± 0.04	0.70 ± 0.04	3.50 ± 0.05	1.00 ± 0.05	1.75 ± 0.10	1.55 ± 0.05	1.00 ± 0.05	0.38 ± 0.04	8.00 ± 0.10	4.00 ± 0.10	0.5 max
0201	J	Paper	A	0.40 ± 0.04	0.70 ± 0.04	3.50 ± 0.05	1.00 ± 0.05	1.75 ± 0.10	1.55 ± 0.05	1.00 ± 0.05	0.38 ± 0.04	8.00 ± 0.10	4.00 ± 0.10	0.5 max
0201	J	Paper	M	0.40 ± 0.04	0.70 ± 0.04	3.50 ± 0.05	2.00 ± 0.05	1.75 ± 0.10	1.55 ± 0.05	2.00 ± 0.05	0.38 ± 0.04	8.00 ± 0.10	4.00 ± 0.10	0.5 max
0201	J	Paper	H	0.40 ± 0.04	0.70 ± 0.04	3.50 ± 0.05	2.00 ± 0.05	1.75 ± 0.10	1.55 ± 0.05	2.00 ± 0.05	0.38 ± 0.04	8.00 ± 0.10	4.00 ± 0.10	0.5 max
0201	J	Paper	L	0.40 ± 0.04	0.70 ± 0.04	3.50 ± 0.05	1.00 ± 0.05	1.75 ± 0.10	1.55 ± 0.05	1.00 ± 0.05	0.38 ± 0.04	8.00 ± 0.10	4.00 ± 0.10	0.5 max
0201	X	Paper	T	0.44 ± 0.06	0.74 ± 0.06	3.50 ± 0.05	2.00 ± 0.05	1.75 ± 0.10	1.55 ± 0.05	2.00 ± 0.05	0.40 ± 0.05	8.00 ± 0.10	4.00 ± 0.10	0.6 max
0201	X	Paper	J	0.44 ± 0.06	0.74 ± 0.06	3.50 ± 0.05	2.00 ± 0.05	1.75 ± 0.10	1.55 ± 0.05	2.00 ± 0.05	0.40 ± 0.05	8.00 ± 0.10	4.00 ± 0.10	0.6 max
0201	X	Paper	H	0.44 ± 0.06	0.74 ± 0.06	3.50 ± 0.05	2.00 ± 0.05	1.75 ± 0.10	1.55 ± 0.05	2.00 ± 0.05	0.40 ± 0.05	8.00 ± 0.10	4.00 ± 0.10	0.6 max
0201	F	Paper	T	0.44 ± 0.06	0.74 ± 0.06	3.50 ± 0.05	2.00 ± 0.05	1.75 ± 0.10	1.55 ± 0.05	2.00 ± 0.05	0.40 ± 0.05	8.00 ± 0.10	4.00 ± 0.10	0.6 max
0201	B	Paper	H	0.44 ± 0.06	0.74 ± 0.06	3.50 ± 0.05	2.00 ± 0.05	1.75 ± 0.10	1.55 ± 0.05	2.00 ± 0.05	0.55 ± 0.05	8.00 ± 0.10	4.00 ± 0.10	0.7 max
0201	B	Paper	T	0.44 ± 0.06	0.74 ± 0.06	3.50 ± 0.05	2.00 ± 0.05	1.75 ± 0.10	1.55 ± 0.05	2.00 ± 0.05	0.55 ± 0.05	8.00 ± 0.10	4.00 ± 0.10	0.7 max
0402	B	Paper	T	0.63 ± 0.05	1.13 ± 0.05	3.50 ± 0.05	2.00 ± 0.05	1.75 ± 0.10	1.55 ± 0.05	2.00 ± 0.05	/	8.00 ± 0.10	4.00 ± 0.10	0.8 max
0402	B	Paper	J	0.63 ± 0.05	1.13 ± 0.05	3.50 ± 0.05	2.00 ± 0.05	1.75 ± 0.10	1.55 ± 0.05	2.00 ± 0.05	/	8.00 ± 0.10	4.00 ± 0.10	0.8 max
0402	N	Paper	T	0.70 ± 0.10	1.20 ± 0.10	3.50 ± 0.05	2.00 ± 0.05	1.75 ± 0.10	1.55 ± 0.05	2.00 ± 0.05	/	8.00 ± 0.10	4.00 ± 0.10	0.8 max
0402	N	Paper	J	0.70 ± 0.10	1.20 ± 0.10	3.50 ± 0.05	2.00 ± 0.05	1.75 ± 0.10	1.55 ± 0.05	2.00 ± 0.05	/	8.00 ± 0.10	4.00 ± 0.10	0.8 max
0402	C	Paper	T	0.75 ± 0.10	1.30 ± 0.10	3.50 ± 0.05	2.00 ± 0.05	1.75 ± 0.10	1.55 ± 0.05	2.00 ± 0.05	/	8.00 ± 0.10	4.00 ± 0.10	0.8 max
0402	C	Paper	J	0.75 ± 0.10	1.30 ± 0.10	3.50 ± 0.05	2.00 ± 0.05	1.75 ± 0.10	1.55 ± 0.05	2.00 ± 0.05	/	8.00 ± 0.10	4.00 ± 0.10	0.8 max
0402	U	Paper	C	0.85 ± 0.10	1.40 ± 0.10	3.50 ± 0.05	2.00 ± 0.05	1.75 ± 0.10	1.55 ± 0.05	2.00 ± 0.05	/	8.00 ± 0.10	4.00 ± 0.10	0.95 max
0402	U	Paper	T	0.85 ± 0.10	1.40 ± 0.10	3.50 ± 0.05	2.00 ± 0.05	1.75 ± 0.10	1.55 ± 0.05	2.00 ± 0.05	/	8.00 ± 0.10	4.00 ± 0.10	0.95 max

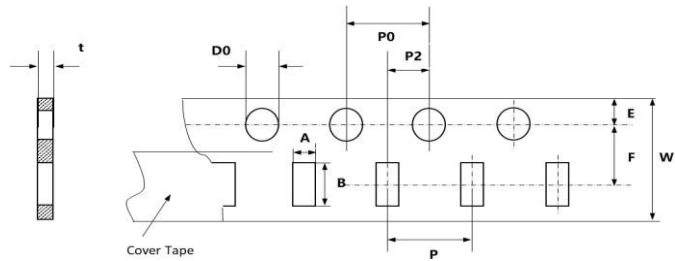

Fig. 5-5 0603, 0805, 1206, 1210 (Paper tape)

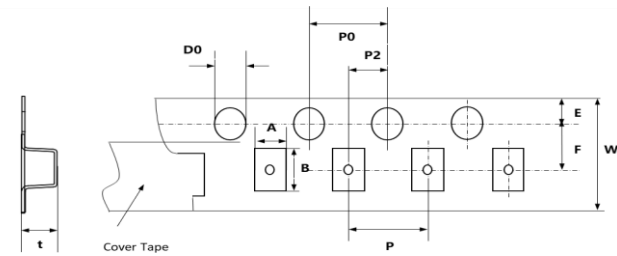

Fig. 5-6 0603,0805,1206,1210 (Plastic tape)

Table 2-2: Carrier size (Size Code:0603, 0805, 1206, 1210)

(Unit:mm)

Size Code	Thickness code	Carrier Tape Type	Packaging Code	A	B	F	P	E	D0	P2	K	W	P0	t
0603	S	Paper	T	1.10 ± 0.10	1.90 ± 0.10	3.50 ± 0.05	4.00 ± 0.10	1.75 ± 0.10	1.55 ± 0.05	2.00 ± 0.05	/	8.00 ± 0.20	4.00 ± 0.10	0.70 max
0603	D	Paper	T	1.00 ± 0.10	1.80 ± 0.10	3.50 ± 0.05	4.00 ± 0.10	1.75 ± 0.10	1.55 ± 0.05	2.00 ± 0.05	/	8.00 ± 0.20	4.00 ± 0.10	1.15 max
0603	D	Paper	A	1.00 ± 0.10	1.80 ± 0.10	3.50 ± 0.05	4.00 ± 0.10	1.75 ± 0.10	1.55 ± 0.05	2.00 ± 0.05	/	8.00 ± 0.20	4.00 ± 0.10	1.15 max
0603	D	Plastic	O	1.00 ± 0.10	1.80 ± 0.10	3.50 ± 0.05	4.00 ± 0.10	1.75 ± 0.10	1.55 ± 0.05	2.00 ± 0.05	/	8.00 ± 0.20	4.00 ± 0.10	1.15 max
0603	D	Paper	W	1.00 ± 0.10	1.80 ± 0.10	3.50 ± 0.05	4.00 ± 0.10	1.75 ± 0.10	1.55 ± 0.05	2.00 ± 0.05	/	8.00 ± 0.20	4.00 ± 0.10	1.15 max
0603	K	Paper	T	1.10 ± 0.10	1.90 ± 0.10	3.50 ± 0.05	4.00 ± 0.10	1.75 ± 0.10	1.55 ± 0.05	2.00 ± 0.05	/	8.00 ± 0.20	4.00 ± 0.10	1.15 max
0603	K	Paper	A	1.10 ± 0.10	1.90 ± 0.10	3.50 ± 0.05	4.00 ± 0.10	1.75 ± 0.10	1.55 ± 0.05	2.00 ± 0.05	/	8.00 ± 0.20	4.00 ± 0.10	1.15 max
0603	K	Plastic	O	1.10 ± 0.10	1.90 ± 0.10	3.50 ± 0.05	4.00 ± 0.10	1.75 ± 0.10	1.55 ± 0.05	2.00 ± 0.05	/	8.00 ± 0.20	4.00 ± 0.10	1.15 max
0603	K	Paper	W	1.10 ± 0.10	1.90 ± 0.10	3.50 ± 0.05	4.00 ± 0.10	1.75 ± 0.10	1.55 ± 0.05	2.00 ± 0.05	/	8.00 ± 0.20	4.00 ± 0.10	1.15 max
0603	K	Plastic	Q	1.10 ± 0.10	1.90 ± 0.10	3.50 ± 0.05	4.00 ± 0.10	1.75 ± 0.10	1.55 ± 0.05	2.00 ± 0.05	/	8.00 ± 0.20	4.00 ± 0.10	1.15 max
0603	K	Plastic	R	1.10 ± 0.10	1.90 ± 0.10	3.50 ± 0.05	4.00 ± 0.10	1.75 ± 0.10	1.55 ± 0.05	2.00 ± 0.05	/	8.00 ± 0.20	4.00 ± 0.10	1.15 max
0603	W	Plastic	R	1.10 ± 0.20	1.90 ± 0.20	3.50 ± 0.05	4.00 ± 0.10	1.75 ± 0.10	1.55 ± 0.05	2.00 ± 0.05	/	8.00 ± 0.20	4.00 ± 0.10	1.35 max
0603	W	Plastic	O	1.10 ± 0.20	1.90 ± 0.20	3.50 ± 0.05	4.00 ± 0.10	1.75 ± 0.10	1.55 ± 0.05	2.00 ± 0.05	/	8.00 ± 0.20	4.00 ± 0.10	1.35 max
0603	W	Plastic	Q	1.10 ± 0.20	1.90 ± 0.20	3.50 ± 0.05	4.00 ± 0.10	1.75 ± 0.10	1.55 ± 0.05	2.00 ± 0.05	/	8.00 ± 0.20	4.00 ± 0.10	1.35 max
0805	C	Paper	T	1.45 ± 0.10	2.20 ± 0.10	3.50 ± 0.05	4.00 ± 0.10	1.75 ± 0.10	1.55 ± 0.05	2.00 ± 0.05	/	8.00 ± 0.20	4.00 ± 0.10	0.9 max
0805	C	Plastic	R	1.45 ± 0.10	2.20 ± 0.10	3.50 ± 0.05	4.00 ± 0.10	1.75 ± 0.10	1.55 ± 0.05	2.00 ± 0.05	/	8.00 ± 0.20	4.00 ± 0.10	0.9 max
0805	K	Paper	T	1.45 ± 0.20	2.20 ± 0.20	3.50 ± 0.05	4.00 ± 0.10	1.75 ± 0.10	1.55 ± 0.05	2.00 ± 0.05	/	8.00 ± 0.20	4.00 ± 0.10	1.15 max
0805	K	Plastic	R	1.45 ± 0.20	2.20 ± 0.20	3.50 ± 0.05	4.00 ± 0.10	1.75 ± 0.10	1.55 ± 0.05	2.00 ± 0.05	/	8.00 ± 0.20	4.00 ± 0.10	1.15 max
0805	K	Plastic	E	1.45 ± 0.20	2.20 ± 0.20	3.50 ± 0.05	4.00 ± 0.10	1.75 ± 0.10	1.55 ± 0.05	2.00 ± 0.05	/	8.00 ± 0.20	4.00 ± 0.10	1.15 max
0805	Y	Paper	T	1.45 ± 0.20	2.20 ± 0.20	3.50 ± 0.05	4.00 ± 0.10	1.75 ± 0.10	1.55 ± 0.05	2.00 ± 0.05	/	8.00 ± 0.20	4.00 ± 0.10	1.15 max
0805	Y	Plastic	E	1.45 ± 0.20	2.20 ± 0.20	3.50 ± 0.05	4.00 ± 0.10	1.75 ± 0.10	1.55 ± 0.05	2.00 ± 0.05	/	8.00 ± 0.20	4.00 ± 0.10	1.15 max
0805	Y	Plastic	P	1.45 ± 0.20	2.20 ± 0.20	3.50 ± 0.05	4.00 ± 0.10	1.75 ± 0.10	1.55 ± 0.05	2.00 ± 0.05	/	8.00 ± 0.20	4.00 ± 0.10	1.15 max
0805	Y	Plastic	R	1.45 ± 0.20	2.20 ± 0.20	3.50 ± 0.05	4.00 ± 0.10	1.75 ± 0.10	1.55 ± 0.05	2.00 ± 0.05	/	8.00 ± 0.20	4.00 ± 0.10	1.15 max
0805	G	Plastic	R	1.45 ± 0.10	2.20 ± 0.10	3.50 ± 0.05	4.00 ± 0.10	1.75 ± 0.10	1.55 ± 0.05	2.00 ± 0.05	/	8.00 ± 0.20	4.00 ± 0.10	1.75 max
0805	G	Plastic	P	1.45 ± 0.10	2.20 ± 0.10	3.50 ± 0.05	4.00 ± 0.10	1.75 ± 0.10	1.55 ± 0.05	2.00 ± 0.05	/	8.00 ± 0.20	4.00 ± 0.10	1.75 max
0805	G	Plastic	O	1.45 ± 0.10	2.20 ± 0.10	3.50 ± 0.05	4.00 ± 0.10	1.75 ± 0.10	1.55 ± 0.05	2.00 ± 0.05	/	8.00 ± 0.20	4.00 ± 0.10	1.75 max
0805	H	Plastic	R	1.45 ± 0.20	2.20 ± 0.20	3.50 ± 0.05	4.00 ± 0.10	1.75 ± 0.10	1.55 ± 0.05	2.00 ± 0.05	/	8.00 ± 0.20	4.00 ± 0.10	2.00 max
0805	H	Plastic	P	1.45 ± 0.20	2.20 ± 0.20	3.50 ± 0.05	4.00 ± 0.10	1.75 ± 0.10	1.55 ± 0.05	2.00 ± 0.05	/	8.00 ± 0.20	4.00 ± 0.10	2.00 max
0805	H	Plastic	O	1.45 ± 0.20	2.20 ± 0.20	3.50 ± 0.05	4.00 ± 0.10	1.75 ± 0.10	1.55 ± 0.05	2.00 ± 0.05	/	8.00 ± 0.20	4.00 ± 0.10	2.00 max
1206	E	Plastic	R	1.80 ± 0.20	3.40 ± 0.20	3.50 ± 0.05	4.00 ± 0.10	1.75 ± 0.10	1.55 ± 0.05	2.00 ± 0.05	/	8.00 ± 0.20	4.00 ± 0.10	1.15 max
1206	E	Plastic	P	1.80 ± 0.20	3.40 ± 0.20	3.50 ± 0.05	4.00 ± 0.10	1.75 ± 0.10	1.55 ± 0.05	2.00 ± 0.05	/	8.00 ± 0.20	4.00 ± 0.10	1.15 max

Table 2-2: Carrier size (Size Code:0603, 0805, 1206, 1210)

(Unit:mm)

Size Code	Thickness code	Carrier Tape Type	Packaging Code	A	B	F	P	E	D0	P2	K	W	P0	t
1206	Y	Plastic	R	1.80 ± 0.20	3.40 ± 0.20	3.50 ± 0.05	4.00 ± 0.10	1.75 ± 0.10	1.55 ± 0.05	2.00 ± 0.05	/	8.00 ± 0.20	4.00 ± 0.10	1.35 max
1206	Y	Plastic	Q	1.80 ± 0.20	3.40 ± 0.20	3.50 ± 0.05	4.00 ± 0.10	1.75 ± 0.10	1.55 ± 0.05	2.00 ± 0.05	/	8.00 ± 0.20	4.00 ± 0.10	1.35 max
1206	O	Plastic	R	1.80 ± 0.20	3.40 ± 0.20	3.50 ± 0.05	4.00 ± 0.10	1.75 ± 0.10	1.55 ± 0.05	2.00 ± 0.05	/	8.00 ± 0.20	4.00 ± 0.10	1.45 max
1206	O	Plastic	P	1.80 ± 0.20	3.40 ± 0.20	3.50 ± 0.05	4.00 ± 0.10	1.75 ± 0.10	1.55 ± 0.05	2.00 ± 0.05	/	8.00 ± 0.20	4.00 ± 0.10	1.45 max
1206	L	Plastic	P	1.80 ± 0.20	3.40 ± 0.20	3.50 ± 0.05	4.00 ± 0.10	1.75 ± 0.10	1.55 ± 0.05	2.00 ± 0.05	/	8.00 ± 0.20	4.00 ± 0.10	2.50 max
1206	L	Plastic	R	1.80 ± 0.20	3.40 ± 0.20	3.50 ± 0.05	4.00 ± 0.10	1.75 ± 0.10	1.55 ± 0.05	2.00 ± 0.05	/	8.00 ± 0.20	4.00 ± 0.10	2.50 max
1206	L	Plastic	E	1.80 ± 0.20	3.40 ± 0.20	3.50 ± 0.05	4.00 ± 0.10	1.75 ± 0.10	1.55 ± 0.05	2.00 ± 0.05	/	8.00 ± 0.20	4.00 ± 0.10	2.50 max
1206	P	Plastic	P	1.90 ± 0.20	3.50 ± 0.20	3.50 ± 0.05	4.00 ± 0.10	1.75 ± 0.10	1.55 ± 0.05	2.00 ± 0.05	/	8.00 ± 0.20	4.00 ± 0.10	2.50 max
1210	L	Plastic	P	2.70 ± 0.20	3.50 ± 0.20	3.50 ± 0.05	4.00 ± 0.10	1.75 ± 0.10	1.55 ± 0.05	2.00 ± 0.05	/	8.00 ± 0.20	4.00 ± 0.10	2.00 max
1210	Q	Plastic	F	2.70 ± 0.20	3.50 ± 0.20	3.50 ± 0.05	4.00 ± 0.10	1.75 ± 0.10	1.55 ± 0.05	2.00 ± 0.05	/	8.00 ± 0.20	4.00 ± 0.10	2.50 max
1210	Q	Plastic	S	2.70 ± 0.20	3.50 ± 0.20	3.50 ± 0.05	4.00 ± 0.10	1.75 ± 0.10	1.55 ± 0.05	2.00 ± 0.05	/	8.00 ± 0.20	4.00 ± 0.10	2.50 max
1210	Q	Plastic	Z	2.70 ± 0.20	3.50 ± 0.20	3.50 ± 0.05	4.00 ± 0.10	1.75 ± 0.10	1.55 ± 0.05	2.00 ± 0.05	/	8.00 ± 0.20	4.00 ± 0.10	2.50 max
1210	R	Plastic	Z	2.70 ± 0.20	3.50 ± 0.30	3.50 ± 0.05	4.00 ± 0.10	1.75 ± 0.10	1.55 ± 0.05	2.00 ± 0.05	/	8.00 ± 0.20	4.00 ± 0.10	3.00 max
1210	R	Plastic	S	2.70 ± 0.20	3.50 ± 0.30	3.50 ± 0.05	4.00 ± 0.10	1.75 ± 0.10	1.55 ± 0.05	2.00 ± 0.05	/	8.00 ± 0.20	4.00 ± 0.10	3.00 max
1210	3	Plastic	Z	2.70 ± 0.20	3.50 ± 0.40	3.50 ± 0.05	4.00 ± 0.10	1.75 ± 0.10	1.55 ± 0.05	2.00 ± 0.05	/	8.00 ± 0.20	4.00 ± 0.10	3.10 max

4.1.3 Disc size

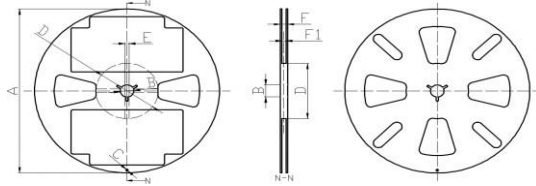

Fig. 6-1 Disc (Width of carrier-4 mm)

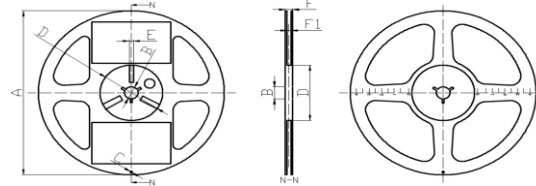

Fig. 6-2 Disc (Width of carrier-8 mm)

Table 3: Disc size

(Unit:mm)

Disc size	Width of carrier	A	B	C	D	E	F	F1	Size Code
7"	8.00 ± 0.10	Φ178 ± 2.0	Φ13 ± 1.0	Φ4.0 ± 0.5	Φ60 ± 2.0	4.0 ± 1.0	11.5 ± 1.0	10.0 ± 2.0	All
13"	8.00 ± 0.10	Φ330 ± 2.0	Φ13 ± 1.0	Φ4.0 ± 0.5	Φ108 ± 2.0	4.0 ± 1.0	13.5 ± 2.0	10.0 ± 2.0	All
7"	4.00 ± 0.10	Φ178 ± 2.0	Φ13 ± 1.0	Φ4.0 ± 0.5	Φ60 ± 2.0	3.5 ± 0.5	7.3 ± 0.5	4.5 ± 1.0	0105/A8A4

4.1.4 Carrier Tape specifications

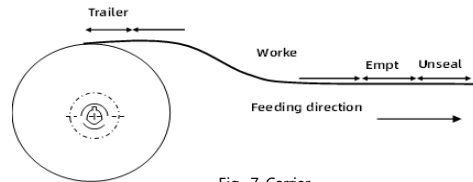

Fig. 7 Carrier

Packaging	The minimum length of the reserved spaces		
	Trailer	Empty	Unseal
Carrier	60 mm	200 mm	160 mm

4.1.5 Performance of Carrier Taping

4.1.5.1 Strength of Carrier Tape and Top Cover Tape

a. Carrier Tape

When a tensile force 1.02 kgf is applied in the direction to unreel the tape, the tape shall withstand this force.

b. Top cover Tape

When a tensile force 1.02 kgf is applied to the tape, the tape shall withstand this force.

4.1.5.2 Peeling Strength of Top Cover Tape

Unless otherwise specified, the peeling strength of top cover tape shall be within 10.2 gf to 71.4 gf when the top cover tape is pulled at a speed of 300 mm/min with the angle of 0° to 15° (see Fig. 8).

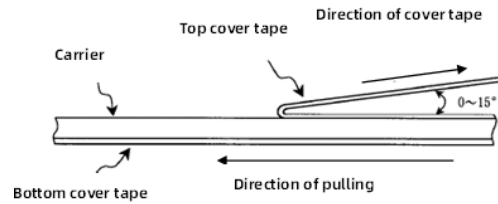

Fig. 8 Cover tape peel-off force

2. Shipment

Transport packaging products to adapt to the modern means of transport, but the product in the process of transport to prevent rain and acid and alkali corrosion, shall not be whipped extrusion casting and gravity.

3. Storage

1. Storage conditions:

The recommended temperature is less than 30 °C.

A temperature is 5 °C to 40 °C and a relative humidity is 20% to 70% as a standard condition.(MSL Level 1)

MLCC may be affected by the storage conditions. Please use them promptly after delivery.

High temperature and humidity conditions and/or prolonged storage may cause deterioration of the packaging materials.

If more than one year has elapsed since delivery, also check the solderability before use.

2. Corrosive gas can react with the termination (external) electrodes or lead wires of capacitors, and result in poor solderability.

Do not store the capacitors in an atmosphere consisting of corrosive gas (e.g.,hydrogen sulfide, sulfur dioxide, chlorine, ammonia gas etc.)

5. MLCC Application of Technical Requirements

5.1 Circuit Design

5.1.1 Operating Temperature

- a. Do not use capacitor above the maximum allowable operating temperature.
- b. Surface temperature including self-heating should be below maximum operating temperature.

5.1.2 Operating Voltage

The operating voltage for capacitors must always be lower than their rated voltage.

5.2 PCB Design

5.2.1 Design of Land-patterns

When the capacitors are mounted on a PCB, the amount of solder at the terminations has a direct effect on the performance of the capacitors.

The greater the amount of solder, the higher the stress on the capacitor. Therefore, when designing land-patterns, it is necessary to consider the appropriate size and configuration of the solder pads.

Size and recommended land dimensions are shown in the following figure and table.

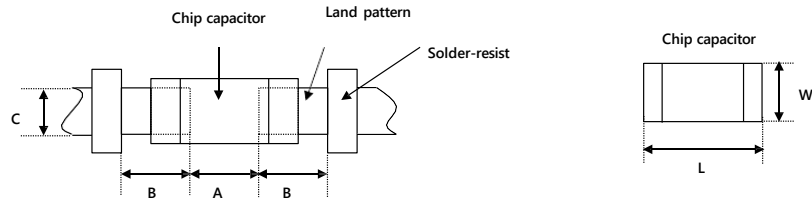

Recommended land dimensions for reflow-soldering

(unit: mm)

Size Code	Length	Width	Tolerance	A	B	C
A8A4	0.25	0.125	all	0.10 - 0.11	0.07 - 0.12	0.125 - 0.145
0105	0.4	0.2	all	0.16 - 0.20	0.12 - 0.18	0.20 - 0.23
0201	0.6	0.3	± 0.03	0.20 - 0.25	0.20 - 0.30	0.20 - 0.35
0201	0.6	0.3	± 0.05	0.20 - 0.25	0.25 - 0.35	0.30 - 0.40
0201	0.6	0.3	± 0.09, ± 0.1	0.23 - 0.30	0.25 - 0.35	0.30 - 0.40
0402	1.0	0.5	± 0.05	0.30 - 0.50	0.35 - 0.45	0.40 - 0.60
0402	1.0	0.5	± 0.15, ± 0.20	0.40 - 0.60	0.40 - 0.50	0.50 - 0.70
0402	1.0	0.5	± 0.30	0.40 - 0.60	0.40 - 0.50	0.50 - 0.80
0603	1.6	0.8	± 0.10	0.60 - 0.80	0.60 - 0.70	0.60 - 0.80
0603	1.6	0.8	± 0.20	0.70 - 0.90	0.70 - 0.80	0.80 - 1.00
0603	1.6	0.8	± 0.25, ± 0.30	0.70 - 0.90	0.70 - 0.90	0.80 - 1.10
0805	2.0	1.25	± 0.10, ± 0.15, ± 0.20	1.00 - 1.40	0.60 - 0.80	1.20 - 1.40
0805	2.0	1.25	± 0.25	1.00 - 1.40	0.70 - 0.90	1.35 - 1.55
1206	3.2	1.6	± 0.15, ± 0.20	1.80 - 2.00	0.90 - 1.20	1.50 - 1.70
1206	3.2	1.6	± 0.30	1.90 - 2.10	1.00 - 1.30	1.60 - 1.90
1210	3.2	2.5	± 0.20	2.00 - 2.40	1.00 - 1.20	2.50 - 2.70
1210	3.2	2.5	± 0.30	2.00 - 2.40	1.10 - 1.30	2.50 - 2.80

5.2.2 Capacitor Layout on PC Board

Mechanical stress varies according to the location of capacitors on PC board. The recommendation for better design is as follows

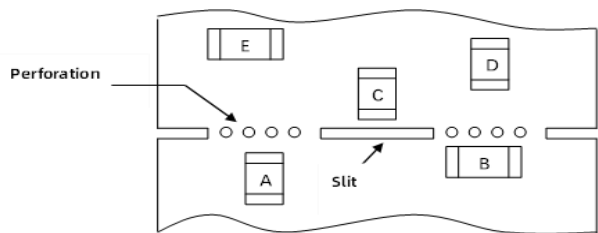

The stress in capacitors is in the following order: $A > B = C > D > E$

Pay attention not to bend or distort the PC board otherwise the capacitor may crack.

Please refer to the following examples of good and bad capacitors layout.

a. Not recommended

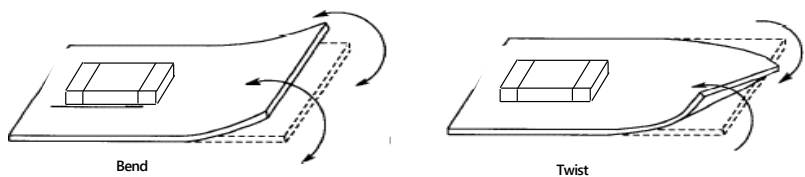

b. Recommended

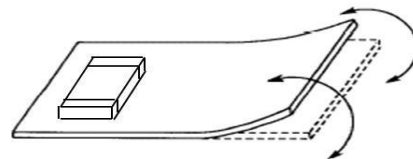

5.2.3 Solder Buildup and Soldering

a. Examples of soldering method not recommended

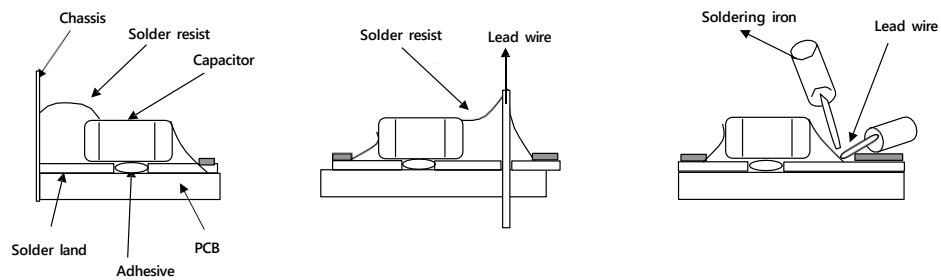

b. Examples of soldering method recommended

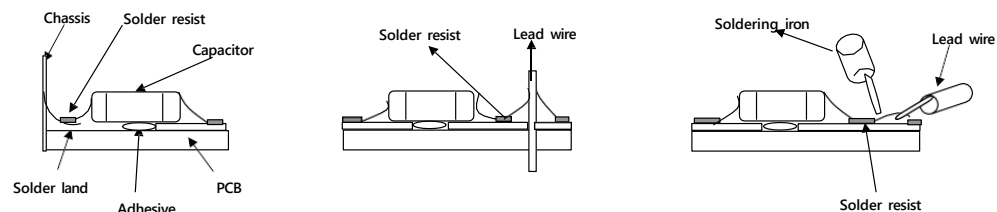

5.3 Consideration for Automatic Placement

If the mounting head is adjusted too low, it may induce excessive stress in the chip capacitor to result in cracking. Please take following precautions

- a. Adjust the bottom dead center of the mounting head to reach on the PC board surface and not press it ;
- b. Adjust the mounting head pressure to be 1N to 3N of static weight ;
- c. To minimize the impact energy from mounting head, it is important to provide support from the bottom side of the PC board.

Please refer to the following samples

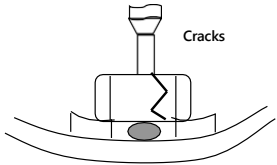
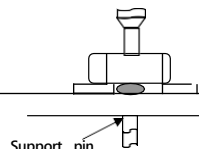
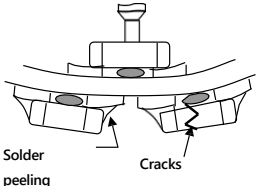
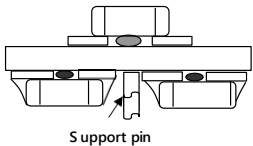
Mounting	Not recommended	Re commended
Singel-sided Mounting		
Double-sided Mounting		

4. Soldering

1. Flux Selection

- a. It is recommended to use a mildly activated rosin flux (less than 0.1wt% chlorine). Strong flux is not recommended.
- b. Please provide proper amount of flux. Excessive flux must be avoided.
- c. When water-soluble flux is used, enough washing is necessary.

5.4.2 Recommended Soldering Profile

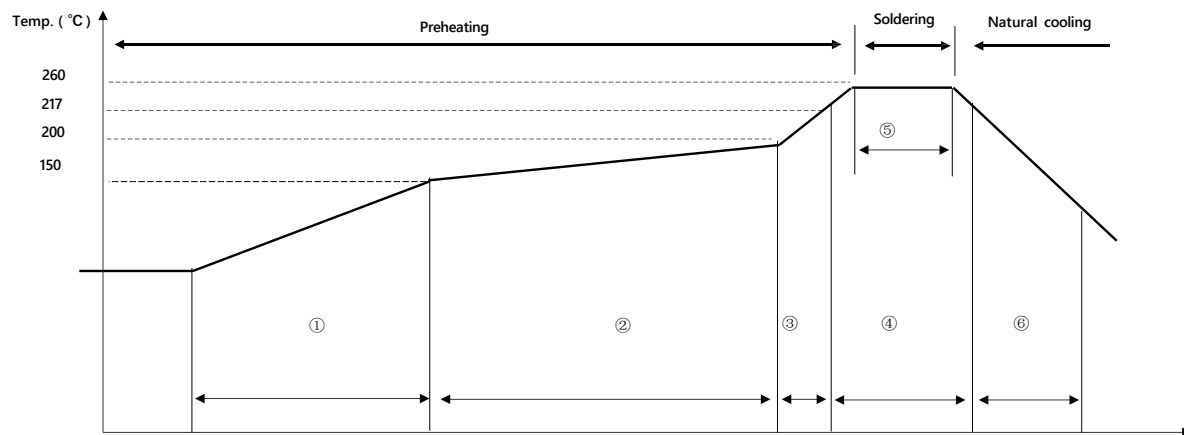

5.4.2.1 Reflow Soldering Condition

NO.	Reflow Soldering zone	Reflow Soldering Condition
①	Preheating 1	$\leq 3 \text{ }^{\circ}\text{C/s}$, $\geq 60 \text{ s}$
②	Constant temperature	$150^{\circ}\text{C}-200^{\circ}\text{C}$, $60 \text{ s}-120 \text{ s}$, $\leq 1 \text{ }^{\circ}\text{C/s}$
③	Preheating 1	$1-5 \text{ }^{\circ}\text{C/s}$
④	Soldering 1	Above $217 \text{ }^{\circ}\text{C}$, $60-150 \text{ s}$
⑤	Soldering 1	Above $260 \text{ }^{\circ}\text{C}$, over 10 s
⑥	Natural cooling	$\leq 6 \text{ }^{\circ}\text{C/s}$

Caution

a. Excessive solder will induce higher tensile force in chip capacitor when temperature changes and result in cracking. Insufficient solder may detach the capacitor from the PC board. The ideal condition is to have solder mass controlled to $1/2$ to $1/3$ of the thickness of the capacitors.

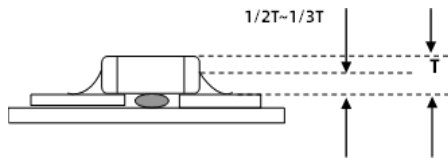

b. Soldering duration should be kept as close to recommended times as possible, because excessive duration can detrimentally affect solderability.

c. The peak temperature of reflow soldering is $245 \text{ }^{\circ}\text{C} \pm 15 \text{ }^{\circ}\text{C}$.

6. All products in this specification comply with the EU RoHS directive

The EU RoHS Directive refers to the "Directive 2011/65/EU on the Restriction of the Use of Certain Hazardous Substances in Electrical and Electronic Equipment" stipulated by the European Union.



PRODUCT NAME:	MLCC For General Purpose C Series SMD 0402 COG 15pF ±5% 50V
REVISION:	A3
NEXTGEN ORDER PART CODE*:	C0402N150J500B
CROSS REF. PART NO.:	
ORIGINAL MFG PART NO.:	C0402COG150J500NTB
ORIGINAL MANUFACTURER:	EYang Technology/Eyang MLCC

*Image shown is a representation only.
Exact specifications should be obtained
from the product dimension*

*: Please Indicate this Part Code For RFQ/Order Support

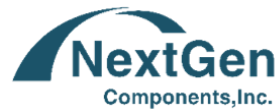

AUTHORIZED DISTRIBUTOR

NextGen Components, Inc.

US Warehouse Location: 9 Orchard Road, Suit 106, Lake Forest, CA 92630, USA

RFQ/Order Support: sales@NextGenComponent.com

Note: This page was created by NextGen Components, Inc. ("NextGen"). The attached last document was created by the part manufacturer, not NextGen, and is provided strictly 'as is.' NextGen, its subsidiaries, affiliates, employees, and agents make no representations or warranties regarding the attached last document and disclaim any liability for the consequences of relying on the information therein. All referenced brands, product names, service names, and trademarks are the property of their respective owners.

HOW TO ORDER

Please Follow Up Part Code Guide And Indicate NextGen Part Code C0402N150J500B For RFQ and new Order.**RFQ**
Request For Quotation

CODE	NAME	KEY SPECIFICATION OPTION
C	Series Code	C: Multilayer Ceramic Chip Capacitors For General Purpose
0402	Case Size	0105 : L0.40*W0.20mm; 0201 : L0.60*W0.30mm; 0402 : L1.00*W0.50mm; 0603 : L1.60*W0.80mm 0805 : L2.00*W1.25mm; 1206 : L3.20*W1.60mm; 1210 : L3.20*W2.50mm
N	Temperature Characteristics	N: NP0 (COG); B: X7R; W: X5R; S: X6S; Y: Y5V; T: X7S; R: X7T
150	Capacitance	Two significant digits followed by number of Zero, The 3rd digit signifies the multiplying factor, and letter R is decimal point. 8R2: 8.2pF; 150: 15pF; 104: 100nF; 680: 68pF; 471: 470pF; 475: 4.7μF
J	Capacitance Tolerance	A: ±0.05pF; B: ±0.1pF; C: ±0.25pF; D: ±0.5pF; F: ±1%; G: ±2%; J: ±5%; K: ±10% L: ±15%; M: ±20%; N: ±30%; P: ±0.02pF; X: ±40%; S: 50%/-20%; Y: 150%/-20% Z: 80%/-20%
500	Rated Voltage	Two significant digits followed by No. of zeros. "R" is in place of decimal point. 6R3: 6.3VDC; 160: 16 VDC; 250: 25 VDC; 100: 10 VDC; 500: 50 VDC; 101: 100VDC
B	Case Thickness	B: 0.8mm Max, See Page 6 (T's Symbol) for Different part code
XX	Internal Control Code	Blank: N/A; XX: Letter A~Z, a~z or digits (0~9) for Special/Custom Parameters

IMPORTANT NOTES AND DISCLAIMER

1. **ROHS COMPLIANCE:** The levels of RoHS restricted materials in this product are below the maximum concentration values (also referred to as the threshold limits) permitted for such substances, or are used in an exempted application, in accordance with EU RoHS Directive (EU) 2015/863 EC (RoHS3). RoHS Test Report for this product can be obtained can be obtained at Download Center.
2. **REACH COMPLIANCE:** REACH substances of high concern (SVHCs) information is available for this product. Since the European Chemical Agency (ECHA) has published notice of their intent to frequently revise the SVHC listing for the foreseeable future, REACH Test Report for this product can be obtained can be obtained at Download Center.
3. All Product parametric performance is indicated in the Electrical Characteristics for the listed herein test conditions, unless otherwise noted. Product performance may not be indicated by the Electrical Characteristics if operated under different conditions.
4. NextGen Component, Inc (*NextGen*) reserves the right to make changes to this document and its products and specifications at any time without notice. Customers should obtain and confirm the latest product information and specifications before final design, purchase or use.
5. *NextGen* makes no warranty, representation or guarantee regarding the suitability of its products for any particular purpose, not does *NextGen* assume any liability for application assistance or customer product design.
6. *NextGen* does not warrant or accept any liability with products which are purchased or used for any unintended or unauthorized application. No license is granted by implication or otherwise under any intellectual property rights of NextGen.
7. *NextGen* products are not authorized for use as critical components in life support devices or systems without express written approval by *NextGen*.
8. *NextGen* requires that customers first obtain an RMA (Returned Merchandise Authorization) number prior to returning any products. Returns must be made within 30 days of the date of invoice, be in the original packaging, unused and like-new condition. At the time of quoting or purchasing, a product may say that it is Non-Cancelable/ Non-Returnable (NCNR). These products are not returnable and not refundable.