



SPECIFICATION SHEET NO.	R1224 - XH16M00000S420	
ORIGINAL MFG/PART NO.	TGS Crystals/CSSX 16M0A30-20-50-40-40TLH/AH3	
NEXTGEN PART CODE	XH16M00000S420	Indicate This Code For RFQ/Order
DATE	Dec. 24, 2024	
REVISION	A3	Updated With Most Recent Data
DESCRIPTION AND MAIN PARAMETRICS	<p>MHz SMD Crystal 4 pads, Hold Type HC-49SX, XH series, Resistance Weld Metal Case, Dimension L12.5*W4.95*H4.0mm 16.000MHz, Tolerance ±30ppm, Load Capacitor 20pF Frequency stability ±50ppm; Operating Temp. Range -40°C ~+85°C, ESR 40 ohm Max, Reflow Profile Condition 260 °C Max. Package in Tape/Reel, 1000pcs/Reel RoHS/RoHS III compliant, RoHS Annex III lead Exemption (exempt per RoHS EU 2015/863)</p>	
CUSTOMER		
CUSTOMER PART NUMBER		
CROSS REF. PART NUMBER	EPSON 406 & 506	
MEMO		

VENDOR APPROVE			
Issued/Checked/Approved			
			
Effective Date: Dec. 24, 2024			

CUSTOMER APPROVE	
Date:	

MAIN FEATURE

- MHz SMD Crystal L12.5*W4.95*H4.0mm 4 Pads
- Resistance Weld Metal Case, Hold Type HC-49SX,
- Low Profile and Short Lead time
- RoHS/RoHS III Compliant, RoHS Annex III Lead Exemption
(exempt per RoHS EU 2015/863)
- Moist are Sensitivity Level (MSL) Level 1
- Excellent Aging and Wide Frequency Range
- 4 Pad Fit EPSON 406 & 506 Footprint Surface Mount
- Replace MHz SMD Plastic Crystal, YQ/CCME series



Image shown is a representation only. Exact specifications should be obtained from the product dimension.



APPLICATION

- Microcontroller Systems, Microprocessors, Communication Interfaces
- Digital Signal Processors (DSPs), Test And Measurement Equipment

ELECTRICAL CHARACTERISTICS

- See Page 7 ~Page 11 For Different Part Code And Rated Voltage.
- All Products Parameters are Subject To NextGen Components' Final Confirmation.

HOW TO ORDER

- Please Follow Up Part Code Guide And Indicate NextGen Part Code XH16M00000S420 For RFQ and Order.

PART CODE GUIDE

RFQ
[Request For Quotation](#)

CODE	NAME	KEY SPECIFICATION OPTION
XH	Series Code	MHz SMD Crystal L12.5*W4.95*H4.0mm 4 Pads Hold Type HC-49SX
16M0	Frequency Range Code	16M0: 16.0MHz or Custom Frequency Range by Page 7~ Page 11
0000S	Internal Control Code	Letter A~Z, a~z or digits (0~9)
420	Parameters code	Special Parameters Code Letter A~Z, a~z or digits (1-9)
()	Special/Custom Parameters Code	Blank: N/A XX: Letter A~Z, a~z or digits (0~9) for Special/Custom Parameters

DIMENSION (Unit: mm)

Top View

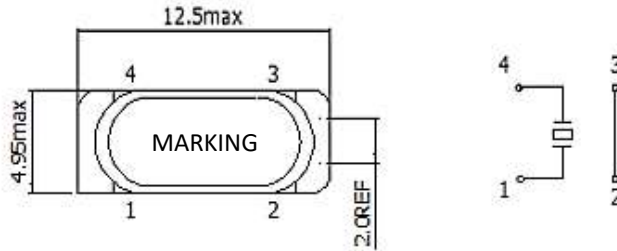

Bottom View



Side View

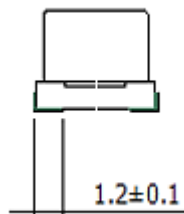

Solder Pattern

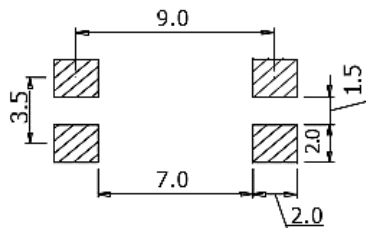

INSIDE STRUCTURE

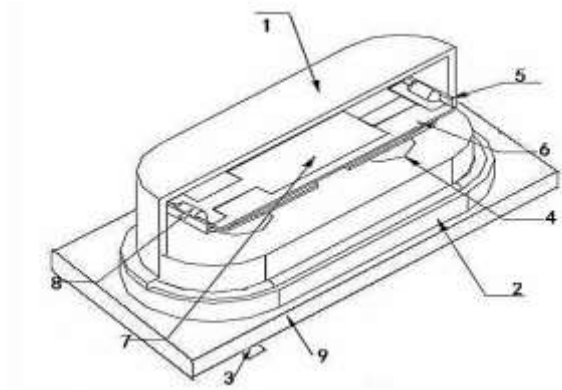

CODE	NAME
1	Cover
2	Base
3	Pad
4	Glass Insulator
5	Clip
6	Quartz Blank
7	Electrode
8	Conductive Adhesive
9	Plastic Board

GENERAL SPECIFICATION

PARAMETER	SYMBOL	VALUE			UNIT	CONDITION
		MIN.	TYPE	MAX.		
Frequency Range	F0	3.072	-	100.00	MHz	Customer specified
Mode of Vibration Code		Fundamental				Optional: 3rd OT Or 5th OT
Frequency Tolerance	$\Delta F/F0$	± 10	± 30	± 30	ppm	at 25°C ± 3 °C
Load Capacitance	CL	6	20	Series	pF	Customer specified
Frequency Stability	Tc	± 30	± 50	± 50	ppm	Customer specified
Operating Temp. Range	TOPR	-40	-	+85	°C	Standard
Storage Temp. Range	TSTG	-40	-	+85	°C	
Equivalent Series Resistance	ESR	See Table 1			Ω	Customer specified
Drive Level	DL	-	-	100	μW	
Insulation Resistance	IR	500	-		m Ω	At 100VDC
Shunt Capacitance	C0	-	-	7.0	pF	
Aging per year	Fa	-5	-	+5	ppm	1st Year

Table 1

FREQUENCY RANGE	MODE OF VIBRATION	ESR (Ω) MAX
3.072MHz \leq F0 \leq 4.000MHz	Fundamental	< 200
4.000MHz< F0 \leq 6.000MHz	Fundamental	< 80
6.000MHz< F0 \leq 8.000MHz	Fundamental	< 50
8.00MHz< F0 \leq 16.000MHz	Fundamental	< 40
16.00MHz< F0 \leq 48.00MHz	Fundamental	< 30
24.00MHz< F0 \leq 40.00MHz	3rd Overtone	< 100
40.00MHz< F0 \leq 80.00MHz	3rd Overtone	< 50
50.00MHz \leq F0 \leq 100.00MHz	5th Overtone	< 100

ELECTRICAL PARAMETERS – FOR DIFFERENT PART CODE- Ta = 25°C

PART CODE	FREQUENCY RANGE	FREQUENCY TOLERANCE	LOAD CAPACITANCE	FREQUENCY STABILITY	OPERATING TEMPE. RANGE	EQUIVALENT SERIES RESISTANCE
	MHz	ppm	pF	ppm	°C	Ω Max.
XH3M579545S416	3.579545	±30	16	±50	-40 ~ +85	200
XH3M579545S418	3.579545	±30	18	±50	-40 ~ +85	200
XH3M579545S420	3.579545	±30	20	±50	-40 ~ +85	200
XH3M686400S416	3.686400	±30	16	±50	-40 ~ +85	200
XH3M686400S418	3.686400	±30	18	±50	-40 ~ +85	200
XH3M686400S420	3.686400	±30	20	±50	-40 ~ +85	200
XH4M000000S410	4.000000	±30	10	±50	-40 ~ +85	200
XH4M000000S416	4.000000	±30	16	±50	-40 ~ +85	200
XH4M000000S418	4.000000	±30	18	±50	-40 ~ +85	200
XH4M000000S420	4.000000	±30	20	±50	-40 ~ +85	200
XH4M915200S416	4.915200	±30	16	±50	-40 ~ +85	80
XH4M915200S418	4.915200	±30	18	±50	-40 ~ +85	80
XH4M915200S420	4.915200	±30	20	±50	-40 ~ +85	80
XH6M000000S416	6.000000	±30	16	±50	-40 ~ +85	80
XH6M000000S418	6.000000	±30	18	±50	-40 ~ +85	80
XH6M000000S420	6.000000	±30	20	±50	-40 ~ +85	80
XH6M144000S418	6.144000	±30	18	±50	-40 ~ +85	50
XH7M372800S416	7.372800	±30	16	±50	-40 ~ +85	50
XH7M372800S418	7.372800	±30	18	±50	-40 ~ +85	50
XH7M372800S420	7.372800	±30	20	±50	-40 ~ +85	50

ELECTRICAL PARAMETERS – FOR DIFFERENT PART CODE- Ta = 25°C

PART CODE	FREQUENCY RANGE	FREQUENCY TOLERANCE	LOAD CAPACITANCE	FREQUENCY STABILITY	OPERATING TEMPE. RANGE	EQUIVALENT SERIES RESISTANCE
	MHz	ppm	pF	ppm	°C	Ω Max.
XH8M000000S416	8.000000	±30	16	±50	-40 ~ +85	50
XH8M000000S418	8.000000	±30	18	±50	-40 ~ +85	50
XH8M000000S420	8.000000	±30	20	±50	-40 ~ +85	50
XH8M000000S40S	8.000000	±30	Series	±50	-40 ~ +85	50
XH8M192000S416	8.192000	±30	16	±50	-40 ~ +85	40
XH8M192000S418	8.192000	±30	18	±50	-40 ~ +85	40
XH8M192000S420	8.192000	±30	20	±50	-40 ~ +85	40
XH9M216000S416	9.216000	±30	16	±50	-40 ~ +85	40
XH9M216000S418	9.216000	±30	18	±50	-40 ~ +85	40
XH9M216000S420	9.216000	±30	20	±50	-40 ~ +85	40
XH9M830400S416	9.830400	±30	16	±50	-40 ~ +85	40
XH9M830400S418	9.830400	±30	18	±50	-40 ~ +85	40
XH9M830400S420	9.830400	±30	20	±50	-40 ~ +85	40
XH10M000000S416	10.000000	±30	16	±50	-40 ~ +85	40
XH10M000000S418	10.000000	±30	18	±50	-40 ~ +85	40
XH10M000000S420	10.000000	±30	20	±50	-40 ~ +85	40
XH10M000000S40S	10.000000	±30	Series	±50	-40 ~ +85	40
XH11M05920S416	11.059200	±30	16	±50	-40 ~ +85	40
XH11M05920S418	11.059200	±30	18	±50	-40 ~ +85	40
XH11M05920S420	11.059200	±30	20	±50	-40 ~ +85	40

ELECTRICAL PARAMETERS – FOR DIFFERENT PART CODE- Ta = 25°C

PART CODE	FREQUENCY RANGE	FREQUENCY TOLERANCE	LOAD CAPACITANCE	FREQUENCY STABILITY	OPERATING TEMPE. RANGE	EQUIVALENT SERIES RESISTANCE
	MHz	ppm	pF	ppm	°C	Ω Max.
XH12M00000S416	12.000000	±30	16	±50	-40 ~ +85	40
XH12M00000S418	12.000000	±30	18	±50	-40 ~ +85	40
XH12M00000S420	12.000000	±30	20	±50	-40 ~ +85	40
XH12M00000S40S	12.000000	±30	Series	±50	-40 ~ +85	40
XH12M28800S416	12.288000	±30	16	±50	-40 ~ +85	40
XH12M28800S418	12.288000	±30	18	±50	-40 ~ +85	40
XH12M28800S420	12.288000	±30	20	±50	-40 ~ +85	40
XH12M500S33418	12.500000	±30	18	±30	-40 ~ +85	40
XH14M31818S416	14.318180	±30	16	±50	-40 ~ +85	40
XH14M31818S418	14.318180	±30	18	±50	-40 ~ +85	40
XH14M31818S420	14.318180	±30	20	±50	-40 ~ +85	40
XH14M74560S416	14.745600	±30	16	±50	-40 ~ +85	40
XH14M74560S418	14.745600	±30	18	±50	-40 ~ +85	40
XH14M74560S420	14.745600	±30	20	±50	-40 ~ +85	40
XH16M00000S416	16.000000	±30	16	±50	-40 ~ +85	40
XH16M00000S418	16.000000	±30	18	±50	-40 ~ +85	40
XH16M00000S420	16.000000	±30	20	±50	-40 ~ +85	40
XH16M38400S416	16.384000	±30	16	±50	-40 ~ +85	30
XH16M38400S418	16.384000	±30	18	±50	-40 ~ +85	30
XH16M38400S420	16.384000	±30	20	±50	-40 ~ +85	30

ELECTRICAL PARAMETERS – FOR DIFFERENT PART CODE- Ta = 25°C

PART CODE	FREQUENCY RANGE	FREQUENCY TOLERANCE	LOAD CAPACITANCE	FREQUENCY STABILITY	OPERATING TEMPE. RANGE	EQUIVALENT SERIES RESISTANCE
	MHz	ppm	pF	ppm	°C	Ω Max.
XH18M00000S418	18.000000	±30	18	±50	-40 ~ +85	30
XH18M43200S416	18.432000	±30	16	±50	-40 ~ +85	30
XH18M43200S418	18.432000	±30	18	±50	-40 ~ +85	30
XH18M43200S420	18.432000	±30	20	±50	-40 ~ +85	30
XH19M66080S416	19.660800	±30	16	±50	-40 ~ +85	30
XH19M66080S418	19.660800	±30	18	±50	-40 ~ +85	30
XH19M66080S420	19.660800	±30	20	±50	-40 ~ +85	30
XH20M00000S416	20.000000	±30	16	±50	-40 ~ +85	30
XH20M00000S418	20.000000	±30	18	±50	-40 ~ +85	30
XH20M00000S420	20.000000	±30	20	±50	-40 ~ +85	30
XH22M11840S416	22.118400	±30	16	±50	-40 ~ +85	30
XH22M11840S418	22.118400	±30	18	±50	-40 ~ +85	30
XH22M11840S420	22.118400	±30	20	±50	-40 ~ +85	30
XH24M00000S416	24.000000	±30	16	±50	-40 ~ +85	30
XH24M00000S418	24.000000	±30	18	±50	-40 ~ +85	30
XH24M00000S420	24.000000	±30	20	±50	-40 ~ +85	30
XH24M00000S40S	24.000000	±30	Series	±50	-40 ~ +85	30
XH24M57600S416	24.576000	±30	16	±50	-40 ~ +85	30
XH24M57600S418	24.576000	±30	18	±50	-40 ~ +85	30
XH24M57600S420	24.576000	±30	20	±50	-40 ~ +85	30

ELECTRICAL PARAMETERS – FOR DIFFERENT PART CODE- Ta = 25°C

PART CODE	FREQUENCY RANGE	FREQUENCY TOLERANCE	LOAD CAPACITANCE	FREQUENCY STABILITY	OPERATING TEMPE. RANGE	EQUIVALENT SERIES RESISTANCE
	MHz	ppm	pF	ppm	°C	Ω Max.
XH25M00000S416	25.000000	±30	16	±50	-40 ~ +85	30
XH25M00000S418	25.000000	±30	18	±50	-40 ~ +85	30
XH25M00000S420	25.000000	±30	20	±50	-40 ~ +85	30
XH26M00000S416	26.000000	±30	16	±50	-40 ~ +85	30
XH26M00000S418	26.000000	±30	18	±50	-40 ~ +85	30
XH26M00000S420	26.000000	±30	20	±50	-40 ~ +85	30
XH27M00000S416	27.000000	±30	16	±50	-40 ~ +85	30
XH27M00000S418	27.000000	±30	18	±50	-40 ~ +85	30
XH27M00000S420	27.000000	±30	20	±50	-40 ~ +85	30
XH28M37500S416	28.375000	±30	16	±50	-40 ~ +85	30
XH28M37500S418	28.375000	±30	18	±50	-40 ~ +85	30
XH28M37500S420	28.375000	±30	20	±50	-40 ~ +85	30
XH30M00000S416	30.000000	±30	16	±50	-40 ~ +85	30
XH30M00000S418	30.000000	±30	18	±50	-40 ~ +85	30
XH30M00000S420	30.000000	±30	20	±50	-40 ~ +85	30
XH32M00000S416	32.000000	±30	16	±50	-40 ~ +85	30
XH32M00000S418	32.000000	±30	18	±50	-40 ~ +85	30
XH32M00000S420	32.000000	±30	20	±50	-40 ~ +85	30
XH40M00000S416	40.000000	±30	16	±50	-40 ~ +85	30
XH40M00000S418	40.000000	±30	18	±50	-40 ~ +85	30
XH40M00000S420	40.000000	±30	20	±50	-40 ~ +85	30

CHARACTERISTICS

Units and values indicated with { } in this specification are the former units and the specified values.

Standard Atmospheric Conditions:

Unless otherwise specified the standard range of atmospheric conditions for making measurements and tests is as follows:

Ambient temperature: 15°C to 35°C

Relative humidity : 25% to 85%

Air pressure : 86 to 106 k Pa

If there is any doubt about the results measurements shall be made within the following limits:

Ambient temperature : $25 \pm 1^\circ\text{C}$

Relative humidity : 63% to 67%

Air pressure : 86 to 106 k Pa

Operating Temperature Range:

The operating temperature range is the range of ambient temperatures at which the quartz crystal oscillator can be stored without damage. Conditions are as specified elsewhere on these specifications.

Operating temperature range: -40°C to +85°C

Storage Temperature Range:

The storage temperature range is the range of ambient temperatures at which the quartz crystal oscillator can be stored without damage. Conditions are as specified elsewhere on these specifications.

Storage temperature range: -55°C to +125°C

MECHANICAL CHARACTERISTICS

Provided that measurement shall be carried out after letting it alone in the room temperature for 1h.

TEST ITEMS	TEST METHOD AND CONDITIONS
Shock	Dropping three times from the height of 50cm onto hard wooden board of thickness more than 30mm.
Vibration	a) Vibration Frequency: 10 To 55hz b) Vibration Amplitude: 0.8mm c) Cycle Time: 1~2min(10-55-10hz) d) Direction: X.Y.Z e) Duration: 2h/Each Direction, total 6Hours
Terminal Strength	Pulling: a) Body of specimen shall be fixed and 8.82N of tension weight shall be supplied gradually to axial direction of terminals/lead-wires for 30s b) After above test a)there is no observation of any visual damages on the specimen Bending: a) Body of specimen shall be fixed and 90 degree bending shall be given being supplied 225g tension weight, After that terminals lead-wires shall be straightened gradually Then the same bending and straightening shall be supplied to the opposite direction in the same axial b) After above tesla)there is no observation of any visual damages on the specimen
Sealing Tightness	There is no observation of gas bubble after specimen put into alcohol below 1atm for 3 min.
Solder ability	Terminals/lead-wires of specimen shall be dipped into solder melted tank at $230\pm 5^{\circ}\text{C}$ for $3\pm 0.5\text{sec}$. Dipping depth shall be 2mm from the bottom of specimen's body. (After applying ROSIN flux) Soldering portion shall be covered in over 90% of terminals/lead-wires dipped
Resistance to Soldering Heat	Terminals/lead-wires of specimen shall be dipped into solder melted tank at $350\pm 10^{\circ}\text{C}$ for 3-4sec. or $260\pm 5^{\circ}\text{C}$ for $5\pm 1\text{sec}$

Note:

- 1) Frequency variation shall be within $\pm 5\text{ppm}$ and equivalent resistance less than $\pm 15\%$ max after the test
- 2) Measuring the frequency should be done after keeping test samples at room temperature for 24 hours

ENVIRONMENTAL CHARACTERISTICS

Provided that measurement shall be carried out after letting it alone in the room temperature for 1h.

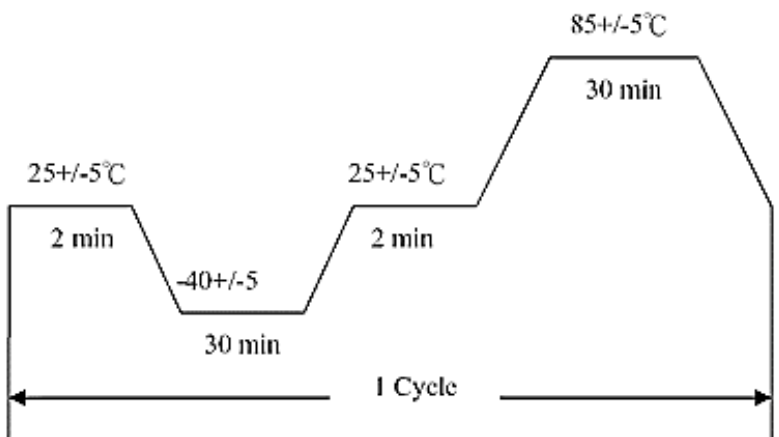
TEST ITEMS	TEST METHOD AND CONDITIONS
Humidity Storage	It alone at 40°C+/-2°C in humidity of 90~95% for 48h
Storage in Low Temperature	It alone at -40°C+/-2°C for 240h
Storage in High Temperature	It alone at -85°C+/-2°C for 240h
Temperature Cycle	<p>The following temperature cycle (10 cycles) Refer to below Fig. Temperature shift from low to high, high to low shall be done in 1°C/C /min.</p> 

Note:

- 1) Frequency variation shall be within ±5ppm and equivalent resistance less than ±15% max after the test
- 2) Measuring the frequency should be done after keeping test samples at room temperature for 24 hours

SUGGESTED REFLOW PROFILE (For Reference Only)



PROFILE FEATURE		HIGH-PB ASSEMBLY
Average Ramp-up Rate (T_s Max to T_p)		3°C/second Max
Preheat	Temperature Min (T_s Min.)	140°C
	Temperature Max (T_s Max.)	180°C
	Time (t_s Min. to t_s Max.)	70 ~ 100 seconds
Time maintained above	Temperature (T_L)	240°C
	Time (t_L)	20 ~ 50 seconds
Peak/Classification Temperature (T_p)		260 °C
Time within 5°C of actual Peak Temperature (t_p)		5 ~ 6 seconds
Ramp-down rate		6 °C /Second Max.
Time 25 °C to Peak Temperature		6 minutes Max.

NOTES

1. Only the lead should be heated when soldering. In case that the package temperature is exceeding 150°C it may impair the crystal or may e cause the crystal quartz 10 destroy.
2. Pulling the lead strongly may cause cracking of the hermetic grass seal bending the lead closely from the case may also cause same problem so when the lead needs to be bent please leave move than 05.mm of lead from the case.
3. Too much shock or vibration is not allowed. According to conditions such as machine shock during the assembly the internal quartz crystal might be damaged. Please check your conditions carefully when using it in advance.
4. Don't storage or use in the environment that temperature may change rapidly to avoid the condensation. And also we recommend to storage the products in the normal environment (Temperature humidity).
5. This product can be subjected to ultrasonic cleaning. However since the oscillator may be affected depending on the condition be sure to check it.
6. Applying excessive drive level to the quartz crystal may cause deterioration for characteristics or damage. Circuit design must be such as to maintain a proper drive level.
7. Unless adequate negative resistance is allocated in the oscillation circuit startup time of oscillation may be increased or no oscillation may occur In order to avoid this provide enough negative resistance in the circuitry design.

TAPE AND REEL (1000pcs/Reel, Unit: mm)

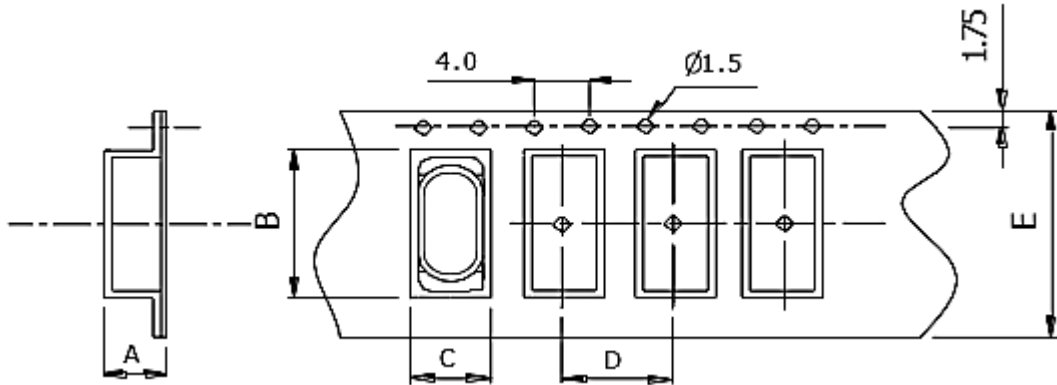

F	E	D	C	B	A
0.40±0.05	24.00±0.30	12.00±0.10	5.00±0.10	14.2±0.20	4.40±0.20

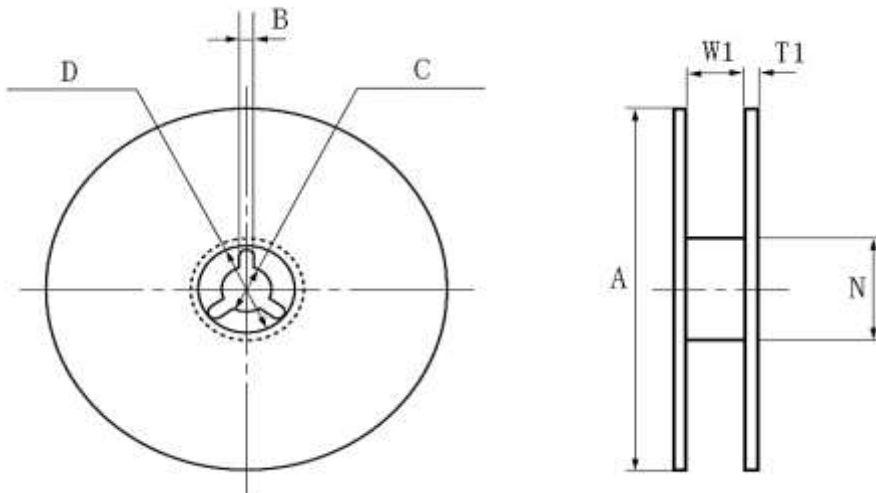

A	B	C	D	N	W1	T1
φ330±0.20	2.50±0.50	φ13.5±0.50	φ21.0±1.00	φ99.0±1.00	24.5±1.00	2.3±0.50

IMPORTANT NOTES AND DISCLAIMER

1. **ROHS COMPLIANCE:** The levels of RoHS restricted materials in this product are below the maximum concentration values (also referred to as the threshold limits) permitted for such substances, or are used in an exempted application, in accordance with EU RoHS Directive (EU) 2015/863 EC (RoHS3). RoHS Test Report for this product can be obtained at Download Center.
2. **REACH COMPLIANCE:** REACH substances of high concern (SVHCs) information is available for this product. Since the European Chemical Agency (ECHA) has published notice of their intent to frequently revise the SVHC listing for the foreseeable future, REACH Test Report for this product can be obtained at Download Center.
3. All Product parametric performance is indicated in the Electrical Characteristics for the listed herein test conditions, unless otherwise noted. Product performance may not be indicated by the Electrical Characteristics if operated under different conditions.
4. NextGen Component, Inc (*NextGen*) reserves the right to make changes to this document and its products and specifications at any time without notice. Customers should obtain and confirm the latest product information and specifications before final design, purchase or use.
5. *NextGen* makes no warranty, representation or guarantee regarding the suitability of its products for any particular purpose, not does *NextGen* assume any liability for application assistance or customer product design.
6. *NextGen* does not warrant or accept any liability with products which are purchased or used for any unintended or unauthorized application. No license is granted by implication or otherwise under any intellectual property rights of NextGen.
7. *NextGen* products are not authorized for use as critical components in life support devices or systems without express written approval by *NextGen*.
8. *NextGen* requires that customers first obtain an RMA (Returned Merchandise Authorization) number prior to returning any products. Returns must be made within 30 days of the date of invoice, be in the original packaging, unused and like-new condition. At the time of quoting or purchasing, a product may say that it is Non-Cancelable/ Non-Returnable (NCNR). These products are not returnable and not refundable.