

SPECIFICATION SHEET

| | | |
|---|--|--|
| SPECIFICATION SHEET NO. | Q1116- YN60K00000S101 | |
| DATE | Nov. 16, 2023 | |
| REVISION | A0 | Updated With Most Recent Data - Official First Release |
| DESCRIPTION AND MAIN PARAMETRICS | KHz SMD Crystals With Metal Lid, Ø2.0*L6.0mm, 2 Pins, CCMA series 60.000KHz, Tolerance: +/-10ppm, Load Capacitance: 12.5pF, Operating Temp. Range -40°C ~+85°C, ESR 50 Kohm Max, Reflow Profile Condition 260 °C Max. Tape/Reel, RoHS/RoHS III compliant, RoHS Annex III lead Exemption (exempt per RoHS EU 2015/863) | |
| CUSTOMER | | |
| CUSTOMER PART NO. | | |
| CROSS REF. PART NO. | | |
| ORIGINAL MFG/PART NO. | TGS/CCMA 60K0A10-12.5-40-50TLH | |
| PART CODE | YN60K00000S101 | |

VENDOR APPROVE

Issued/Checked/Approved



DATE: Nov. 16, 2023

CUSTOMER APPROVE

DATE:

11/16/2023

KHZ SMD CRYSTALS CCMA SERIES

MAIN FEATURE

- KHz SMD Crystal, Metal Lid, Ø2.0*L6.0mm, 2 pins
- Typical Load Capacitance: 12.5pF
- Operating Temperature Range -40°C ~+85°C
- Low cost, High precision, High frequency stability
- Reflow Profile Condition 260 °C Max.
- Cross more competitors part
- RoHS/RoHS III compliant



APPLICATION

- Clock source for Portable
- Microcomputer & Automotive Equipment with Low power consumption

PART CODE GUIDE

RFQ
Request For Quotation

| | | | |
|-----------|-----------------|----------|------------|
| YN | 60K00000 | S | 101 |
| 1 | 2 | 3 | 4 |

1. YN: Part family Code for KHz SMD Crystal, Metal Lid, Ø2.0*L6.0mm, 2 pins
2. 60K00000: Frequency range code for 60.00000KHz
3. S: SMD type, Package Tape/Reel, 3000pcs/Reel
4. 101: Internal Control Code or special Parameters code letter A~Z or digits (1-9)

DIMENSION (Unit: mm)

Image for reference

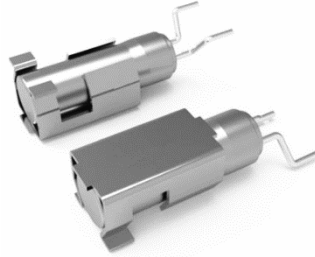

Marking

Frequency Rang

Package code

CCMA, Metal Lid,
Ø2.0*L6.0mm, 2 pins

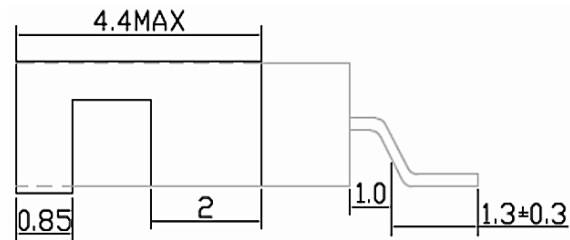
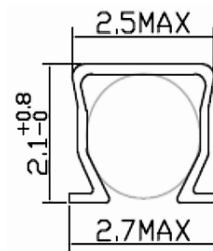
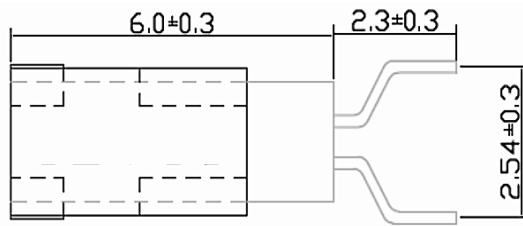

Recommend

Pad Layout

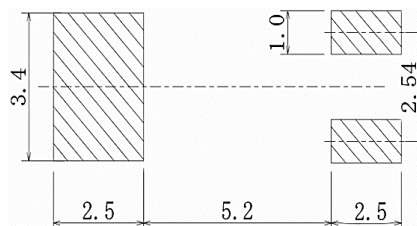

KHZ SMD CRYSTALS CCMA SERIES
ELECTRICAL PARAMETERS

| Parameters | Symbol | Units | Value | | | Condition |
|------------------------------------|-------------|--|--|---------|-------|-----------------------|
| | | | Min. | Typical | Max. | |
| Original Manufacturer | TGS | TGS Crystals | | | | |
| Holder Type | CCMA | KHz SMD Crystals Metal Lid, Ø2.0*L6.0mm 2 pins | | | | |
| Frequency Range | 60K0 | KHz | 60.00000 | | | |
| Mode of Oscillation | A | AT Fundamental | | | | |
| Frequency Tolerance | 10 | ppm | -10 | | +10 | @25°C |
| Load Capacitance (CL) | -12.5 | pF | 12.5 | | | |
| Frequency Temp. Coefficient (K) | | ppm/C ² | -0.040 | 0.034 | 0.040 | |
| Operating Temp. Range | -40 | °C | -40 | | +85 | |
| Storage Temp. Range | | °C | -55 | | +125 | |
| Equivalent Series Resistance (ESR) | -50 | KΩ | | | 50 | |
| Drive Level (DL) | | μW | | | 1.0 | |
| Shunt Capacitance (C0) | | pF | 0.9 | 1.35 | 2.0 | |
| Motional Capacitance (C1) | | fF | | 2.3 | | |
| Turnover Temp | | °C | +20 | +25 | +30 | |
| Quality Factor (Q) | | | 60000 | | | |
| Capacitance Ratio (R) | | | 450 | | | |
| Aging per Year | | ppm | | | ±5 | @1 st year |
| Insulation Resistance | | MΩ | 500 | | | @100Vdc, ± 15Vdc |
| Other | Package | T | Tape/Reel, 3000pcs/Reel | | | |
| | RoHS Status | LH | RoHS/RoHS III compliant, RoHS Annex III lead Exemption (exempt per RoHS EU 2015/863) | | | |
| | Code | | Internal Control Code or Specify | | | |

TEST STANDARD

General Electrical Characteristics And Visual testing

- LOT CLASSIFICATION : If The Quantity Is 1000pcs Or More, 1000 PCS Is One Lot
- Sampling Test Method : MIL-STD-105E G-II
- Test Level
- High Level Defect : AQL 0.065% [200 Pcs]
- Medium Level Defect : AQL 0.25% [50 Pcs]
- Low Level Defect :AQL 0.4% [32 Pcs]
- Defect Classification:
- High Level:

@No Frequency; @Mixing; @Leak Defect

- Medium Level - Electrical Characteristic Defect :

@Frequency; @Oscillation; @Electrical Current; @Other Electrical Characteristics Defect

- Visual : @Marking; @Welding; @Leads ; @Other Visual Defect

Testing Method And Its Standard Can Be Modified Depending On The Customer's Request

Equivalent Circuits

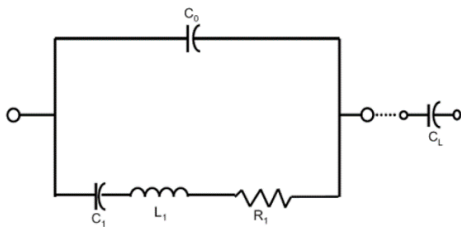

Symbol for crystal unit

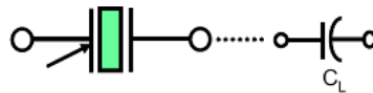

EXEMPTION RULE

- SMD Tuning Fork Crystal series contain Pb chemical substance where solder material is over limitation. The location see at below drawing, The solder purpose is base connected with chip crystal blank.

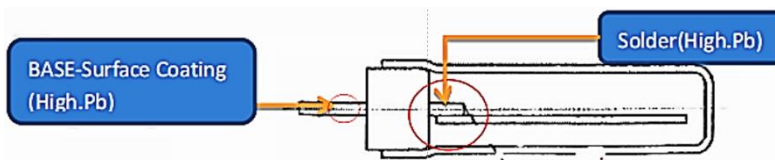

- Below statement is that exemption rule: Lead in high melting temperature type solders (i.e. lead-based alloys containing 85 % by weight or more lead).

KHZ SMD CRYSTALS CCMA SERIES

RELIABILITY (Mechanical And Environmental Endurance)

| TEST ITEMS | TEST METHOD AND CONDITIONS | REQUIREMENTS |
|--------------------------------|--|--|
| Vibration | <ol style="list-style-type: none"> Vibration Frequency: 10 To 55hz Vibration Amplitude: 1.5mm Cycle Time: 1~2min(10-55-10hz) Direction: X.Y.Z Duration: 2h/Each Direction (G-force: ≥5g | Frequency Change: ±10ppm Max. Resistance Change: ± 15% RRMax |
| Shock | 3 Times Free Drop From 75cm Height To Hard Wooden Board Of Thickness More Than 30mm. | Frequency Change: ±10ppm Max. Resistance Change: ± 15% RRMax. |
| Leakage | Put Crystal Units Into A Hermetic Container And Helium For 0.5-0.6. MPA and Keep It For 1h;check The Leakage By A Helium Leak Detector. | Leakage:1x10 ⁻⁸ mbar.L/S Max. |
| Solderability | <ol style="list-style-type: none"> Dip The Leads Into Flu X (ROJIN Methanol) For 3~5s. Dip The Leads Into 245±5°C 99% Sn Dipping Solution For 5s. | The Dipped Part Of The Leads Should Have 95% SN Coating. |
| Soldering Heat Resistance Test | <ol style="list-style-type: none"> Perform Electrical Characteristics Test Before Starting This Procedure. Dip The Leads Into Flux(Rojin Methanol) 5±0.5s. Dip The Leads Into 260±5°C 99% Sn Dipping Solution For 5s. Take The Unit Out ,Store At Room Temper For 30s Then Measure The Electrical Characteristics. | Should Pass Sealing And Visual Test. Frequency Change: ±10ppm Max. |
| Leak Test | Use Helium Leak Detector. Bombing Pressure:5kg/Cm ² Bombing Time: 2 Hours Leak Should Be Less Than 1e-8 Atm. Cc/Sec. | Gas Or Air Should Not Be Detected. |

KHZ SMD CRYSTALS CCMA SERIES

RELIABILITY (Mechanical And Environmental Endurance)

| TEST ITEMS | TEST METHOD AND CONDITIONS | REQUIREMENTS |
|----------------------------|--|---|
| High Temperature Endurance | The Crystal Units Shall Be Put In Somewhere For 500 Hours At Temperature Of 125°C ±5°C ,Then Keep It For 1 To 2 Hours Under Room Temperature. | Frequency Change: ±10ppm Max. Resistance Change: ± 15%rrmax. |
| Low Temperature Endurance | The Crystal Units Shall Be Put In Somewhere For 500 Hours At Temperature Of -40°C ,Then Keep It For 1 To 2 Hours Under Room. | Frequency Change: ±10ppm Max. Resistance Change: ± 15% RRMax |
| Humidity Endurance | Somewhere At 40°C ±5°C In Relative Humidity Of 90%~95% For 72 Hours, Then Keep It For One Or Two Hours Under Room Temperature | Frequency Change: ±10ppm Max. Resistance Change: ± 15% RRMax |
| Temperature Cycle | Temperature Shift From Low(-40°C) To High(100°C,keep 30 Minutes),satisfy High(100°C) To Low(-40°C ,Keep 30 Minutes),then Go Up To Room Temperature For 10 Cycles. | Frequency Change: ±10ppm Max. Resistance Change: ± 15% RRMax |
| Lead Tensibly | <ol style="list-style-type: none"> 1. Fix The Unit. 2. Apply 2lb Of Weight Axis To The Leads. 3. (Time:5s | Should Pass Sealing And Visual Test. |
| Lead Bending | <ol style="list-style-type: none"> 1. Attach 1lb Of Weight To Each Of The Leads. 2. Bending Angle:90° (from The Normal Position To 45°opposte Direction) 3. Bending Time:3s(each Direction) Number Of Bending:2times 4. Number Of Bending:2times | Should Pass Sealing And Visual Test. |
| Marking Erase | Submerge The Unit Into Ipa [isopropyl Alcohol] Solution For 10minutes And Brush The Marking 10 Times With A Tooth Brush. | Marking Should Not Be Erased. |

SUGGESTED REFLOW PROFILE (For Reference Only)

Total time: 200 Sec. Max. Solder melting point: 220°C

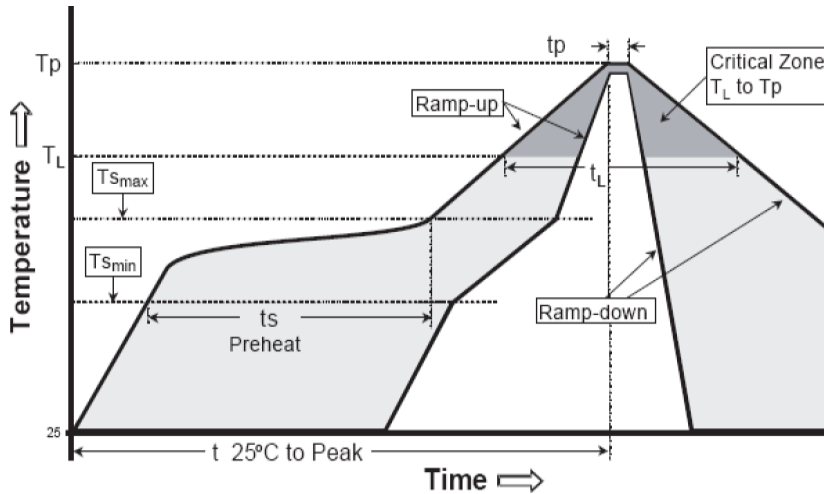

| PROFILE FEATURE | | PB-FREE ASSEMBLY |
|--|----------------------------------|-------------------|
| Average Ramp-up Rate (T_s Max to T_p) | | 3°C/second Max |
| Preheat | Temperature Min (T_s Min.) | 125°C |
| | Temperature Max (T_s Max.) | 200°C |
| | Time (t_s Min. to t_s Max.) | 60 ~ 180 seconds |
| Time maintained above | Temperature (T_L) | 217°C |
| | Time (t_L) | 60 ~ 150 seconds |
| Peak/Classification Temperature (T_p) | | 260 °C |
| Time within 5°C of actual Peak Temperature (t_p) | | 20 ~ 40 seconds |
| Ramp-down rate | | 6 °C /Second Max. |
| Time 25 °C to Peak Temperature | | 8 minutes Max. |
| Suggest reflow times | | 3 Times Max. |

KHZ SMD CRYSTALS CCMA SERIES

TAPE/REEL (Unit: mm)

All Devices are packed in accordance with EIA standard RS-481-2 and specifications, 3000pcs/Reel

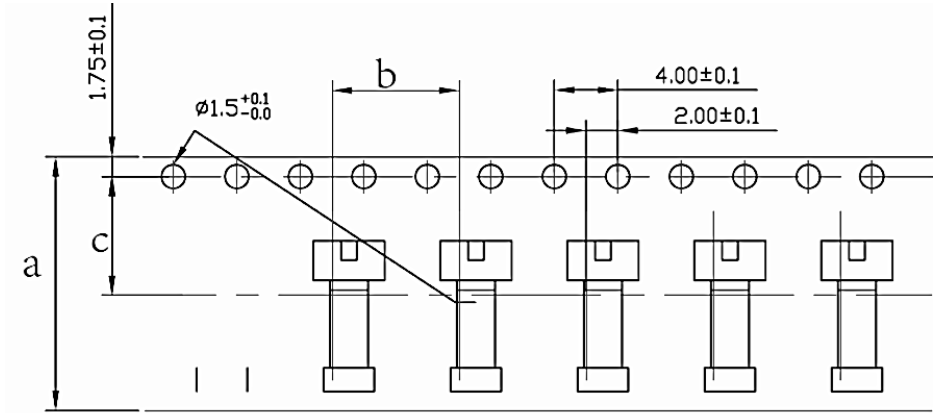

| Symbol | a | b | c |
|-----------|------|-----|-----|
| Dimension | 16.0 | 8.0 | 7.5 |

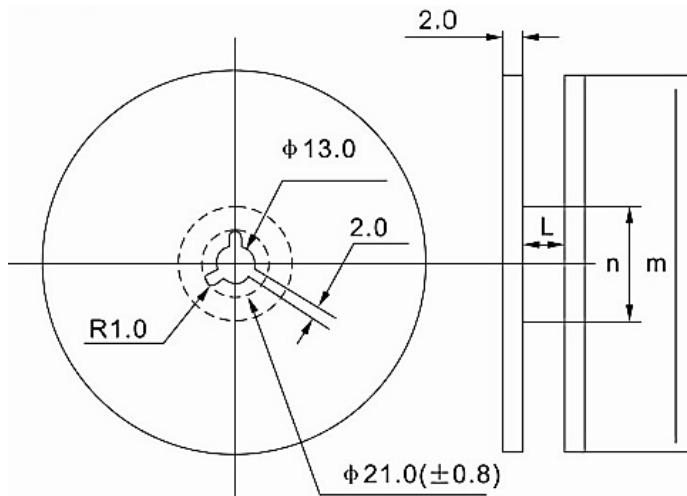

| Symbol | ϕm | ϕn | L | Carrier tape size |
|-----------|----------|----------|------|-------------------|
| Dimension | 330±3 | 80 Min. | 17.5 | 16 |

CAUTION

In Order To Maintain Quality. Without Change In Characteristics Of The crystal Units. Please Follow Below Recommendation

Shock

All Crystal Units Have A Thin Crystal Blanks Within If It Is Dropped Above The Recommended Dropping Height (500mm) The Specific Characteristics And Appearance Can Be Changed Please Pay Special Attention To External Shock

Environmental

1. Crystal Units' Frequency Can Be Changed Due To Surrounding Temperature If It Is Stored Next To A High Temperature Heter (Above+85'c) Or Below 40'c.And A Strong Light Source For Long Period Of Time. The Electrical Characteristics Can Be Changed It Is Suggested That These Environment Be Avoided
2. If The Unit Is Placed In A Humid Environment. Lead Terminal Can Be Damaged: Therefore. Do Not Store The Crystal Units In A Humid Environment
3. Crystal unit Has Vibrating Characteristics If It Is Placed Where Vibration Exists The Operating Characteristics Can Be Altered; Therefore This Environment Should Be Avoided

Leads

1. If The Leads Are Bent 90°from Its Axis For More Than 2 Times The Terminal Could Be Disconnected; Therefore Do Not Bent The Leads
2. After Soldering Crystal Units Into A PCB Impacting The Unit From The top, bottom Left Or Right Side Of The Unit Can Shatter The Glass Portion Of The Base Rendering The Unit Useless

Assembly Method

1. Correct Ultrasonic Frequency For Cleaning Should Be Less Than 20khz
2. SOLDERING SHOULD BE BONE USING IEC 61760-1 OR Pb-free Products

Storage

If The Crystal Units Are Stored In Humid Or Salty Environment Appearance Can Be Changed And Solderability Can Deteriorate; Therefore avoid Storing In Such Environment Do Not Store The Crystal Unit More Than 3 Months

DISCLAIMER

1. All Product parametric performance is indicated in the Electrical Characteristics for the listed herein test conditions, unless otherwise noted. Product performance may not be indicated by the Electrical Characteristics if operated under different conditions.
2. NextGen Component, Inc (*NextGen*) reserves the right to make changes to this document and its products and specifications at any time without notice. Customers should obtain and confirm the latest product information and specifications before final design, purchase or use.
3. *NextGen* makes no warranty, representation or guarantee regarding the suitability of its products for any particular purpose, nor does NextGen assume any liability for application assistance or customer product design.
4. *NextGen* does not warrant or accept any liability with products which are purchased or used for any unintended or unauthorized application. No license is granted by implication or otherwise under any intellectual property rights of NextGen.
5. *NextGen* products are not authorized for use as critical components in life support devices or systems without express written approval by *NextGen*.
6. *NextGen* requires that customers first obtain an RMA (Returned Merchandise Authorization) number prior to returning any products. Returns must be made within 30 days of the date of invoice, be in the original packaging, unused and like-new condition. At the time of quoting or purchasing, a product may say that it is Non-Cancelable/ Non-Returnable (NCNR). These products are not returnable and not refundable.