



**SPECIFICATION SHEET**

<b>SPECIFICATION SHEET NO.</b>	N0310-SOD123F00S24CA
<b>DATE</b>	Mar. 10, 2021
<b>REVISION</b>	A0
<b>DESCRIPTION</b>	<p>SMD Transient Voltage Suppressor (TVS) Diodes, SOD-123FL series, SMF24CA Type, 2 Pads</p> <p>Stand-off Voltage 24V Max. Power Dissipation: 200 Watts</p> <p>Operating Temp. Range -55°C ~+150°C</p> <p>Package in Tape/Reel, 3000pcs/Reel</p> <p>RoHS/RoHS III compliant</p>
<b>CUSTOMER</b>	
<b>CUSTOMER PART NUMBER</b>	
<b>CROSS REF. PART NUMBER</b>	
<b>ORIGINAL PART NUMBER</b>	MDD SMF24CA
<b>PART CODE</b>	SOD123F00S24CA

<b>VENDOR APPROVE</b>			
Issued/Checked/Approved			
DATE: March 10, 2021			

<b>CUSTOMER APPROVE</b>	
DATE:	

**SMD TVs DIODES SOD-123FL SERIES**



**MAIN FEATURE**

- Low profile package
- Glass passivated chip junction
- Low inductance
- Plastic package has Underwriters Laboratory Flammability

**APPLICATION**

- For SMD application

**RFQ**

[Request For Quotation](#)

**PART CODE GUIDE**

<b>SOD123F</b>	<b>00</b>	<b>S</b>	<b>24CA</b>
1	2	3	4

- 1) **SOD123F00**: SMD Transient Voltage Suppressor (TVs) Diodes, SOD123FL series
- 2) **00**: Type code for original part number SMF24CA
- 3) **S**: Package code, Tape/reel, 3000pcs/reel.
- 4) **24CA**: Marking code for "24CA" on the case surface, Different Marking for different specification.

**SMD TVs DIODES SOD-123FL SERIES**

**MORE ITEMS AVAILABLE- Unidirectional Type**

SOD123F00S5.0A	SOD123F00S6.0A	SOD123F00S6.5A	SOD123F00S7.0A	SOD123F00S7.5A
SOD123F00S8.0A	SOD123F00S8.5A	SOD123F00S9.0A	SOD123F00S10A	SOD123F00S11A
SOD123F00S12A	SOD123F00S13A	SOD123F00S14A	SOD123F00S15A	SOD123F00S16A
SOD123F00S17A	SOD123F00S18A	SOD123F00S20A	SOD123F00S22A	SOD123F00S24A
SOD123F00S26A	SOD123F00S28A	SOD123F00S30A	SOD123F00S33A	
SOD123F00S36A	SOD123F00S40A	SOD123F00S43A	SOD123F00S45A	SOD123F00S48A
SOD123F00S51A	SOD123F00S54A	SOD123F00S58A	SOD123F00S60A	SOD123F00S64A
SOD123F00S70A	SOD123F00S75A	SOD123F00S78A	SOD123F00S85A	SOD123F00S90A
SOD123F00S100A	SOD123F00S110A	SOD123F00S120A	SOD123F00S150A	SOD123F00S160A
SOD123F00S170A				

**MORE ITEMS AVAILABLE- Bidirectional Type**

SOD123F0S5.0CA	SOD123F0S6.0CA	SOD123F0S6.5CA	SOD123F0S7.0CA	SOD123F0S7.5CA
SOD123F0S8.0CA	SOD123F0S8.5CA	SOD123F0S9.0CA	SOD123F0S10CA	SOD123F0S11CA
SOD123F0S12CA	SOD123F0S13CA	SOD123F0S14CA	SOD123F0S15CA	SOD123F0S16CA
SOD123F0S17CA	SOD123F0S18CA	SOD123F0S20CA	SOD123F0S22CA	<b>SOD123F00S24CA</b>
SOD123F0S26CA	SOD123F0S28CA	SOD123F0S30CA	SOD123F0S33CA	
SOD123F0S36CA	SOD123F0S40CA	SOD123F0S43CA	SOD123F0S45CA	SOD123F0S48CA
SOD123F0S51CA	SOD123F0S54CA	SOD123F0S58CA	SOD123F0S60CA	SOD123F0S64CA
SOD123F0S70CA	SOD123F0S75CA	SOD123F0S78CA	SOD123F0S85CA	SOD123F0S90CA
SOD123F0S100CA	SOD123F0S110CA	SOD123F0S120CA	SOD123F0S150CA	SOD123F0S160CA
SOD123F0S170CA				

**DIMENSION (Unit: Inch/mm)**

Image for reference



Marking: 24CA

SOD-123FL

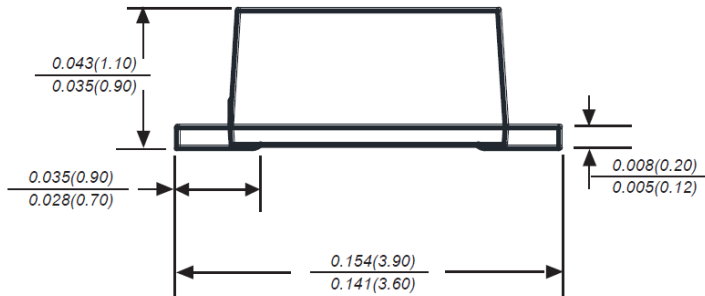
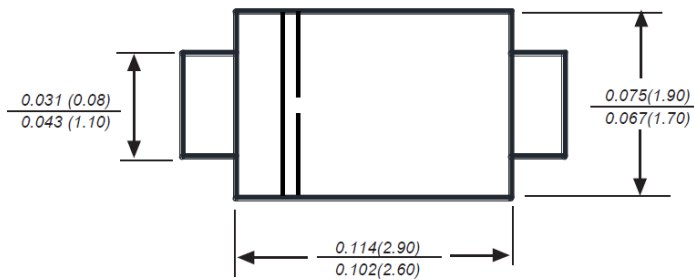

Recommend Pad Layout

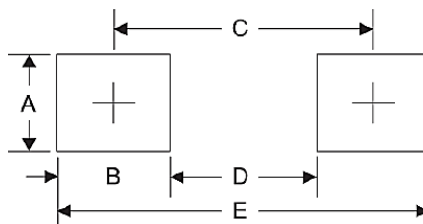

Symbol	Unit (Inch)	Unit (mm)
A	0.047	1.20
B	0.047	1.20
C	0.126	3.20
D	0.079	2.00
E	0.173	4.40

**SMD TVs DIODES SOD-123FL SERIES**
**MECHANICAL DATA**

Case	Terminals	Polarity	Mounting Position	Weight per piece
JEDEC SOD-123FL molded plastic body	Solder plated, Solderable per MIL-STD-750, Method 2026	Polarity symbol marking on case	Any	0.0007 Ounce, 0.0198 grams

**MAX. RATING & CHARACTERISTICS - Ratings at 25°C ambient temperature unless otherwise specified.**

Parameter	SYMBOLS	VALUE			UNITS
		Min.	Typical	Max.	
Peak Pulse Power Dissipation on TA=25°C (Note 1,2,5, Fig1)	P PPM		200		W
Peak Forward Surge Current (Note 3)	I FSm(UNI)		30		A
Peak Pulse Current on 10/1000 us waveform (Note 1) Fig 2)	I PPM			5.1	A
Steady State Power Dissipation (Note 4)	P M(AV)		1.0		W
Thermal resistance	R QJA		180		°C/W
Operating junction temperature range	T J	-55		+150	°C
Storage temperature range	T STG	-55		+150	°C

**Note**

1. Non-repetitive current pulse, per Fig 3 and derated above TA=25 °C per Fig 2
2. Mounted on 5.0\*5.0mm(Thickness 0.03mm) copper pads to each terminal
3. 8.3ms single half sine – wave or equivalent square wave, duty cycle – 4 pulsed per minute Max

**ELECTRICAL CHARACTERISTICS - Ratings at 25°C**

Parameter	SYMBOLS	VALUE	UNITS
Reverse Stand-Off Voltage	V RWM	24.0	V
Breakdown Voltage @I T	V BR	26.7~29.5	V
Test Current	I T	1	mA
Maximum Clamping Voltage @I PP	V C	38.9	V
Peak Pulse Current	I PP	5.1	A
Reverse Leakage @V RWM	I R	1	μA

**SMD TVs DIODES SOD-123FL SERIES**

**RELIABILITY**

Number	Experiment Items	Experiment Method And Conditions	Reference Documents
1	Solder Resistance Test	Test 260°C± 5°C for 10 ± 2 sec. Immerse body into solder 1/16" ± 1/32"	MIL-STD-750D METHOD-2031.2
2	Solderability Test	230°C ±5°C for 5 sec.	MIL-STD-750D METHOD-2026.1 0
3	Pull Test	1 kg in axial lead direction for 10 sec.	MIL-STD-750D METHOD-2036.4
4	Bend Test	0.5Kg Weight Applied To Each Lead, Bending Arcs 90 °C ± 5 °C For 3 Times	MIL-STD-750D METHOD-2036.4
5	High Temperature Reverse Bias Test	TA=100°C for 1000 Hours at VR=80% Rated VR	MIL-STD-750D METHOD-1038.4
6	Forward Operation Life Test	TA=25°C Rated Average Rectified Current	MIL-STD-750D METHOD-1027.3
7	Intermittent Operation Life Test	On state: 5 min with rated IRMS Power Off state: 5 min with Cool Forced Air. On and off for 1000 cycles.	MIL-STD-750D METHOD-1036.3
8	Pressure Cooker Test	15 PSIG, TA=121°C, 4 hours	MIL-S-19500 APPENOIXC
9	Temperature Cycling Test	-55°C~+125°C; 30 Minutes For Dwelled Time 5 minutes for transferred time. Total: 10 cycles.	MIL-STD-750D METHOD-1051.7
10	Thermal Shock Test	0°C for 5 minutes., 100°C for 5minutes, Total: 10 cycles	MIL-STD-750D METHOD-1056.7
11	Forward Surge Test	8.3ms Single Sale Sine-wave One Surge.	MIL-STD-750D METHOD-4066.4
12	Humidity Test	TA=65°C, RH=98% for 1000 hours.	MIL-STD-750D METHOD-1021.3
13	High Temperature Storage life Test	150°C for 1000 Hours	MIL-STD-750D METHOD-1031.5

**SUGGESTED REFLOW PROFILE (For Reference Only)**

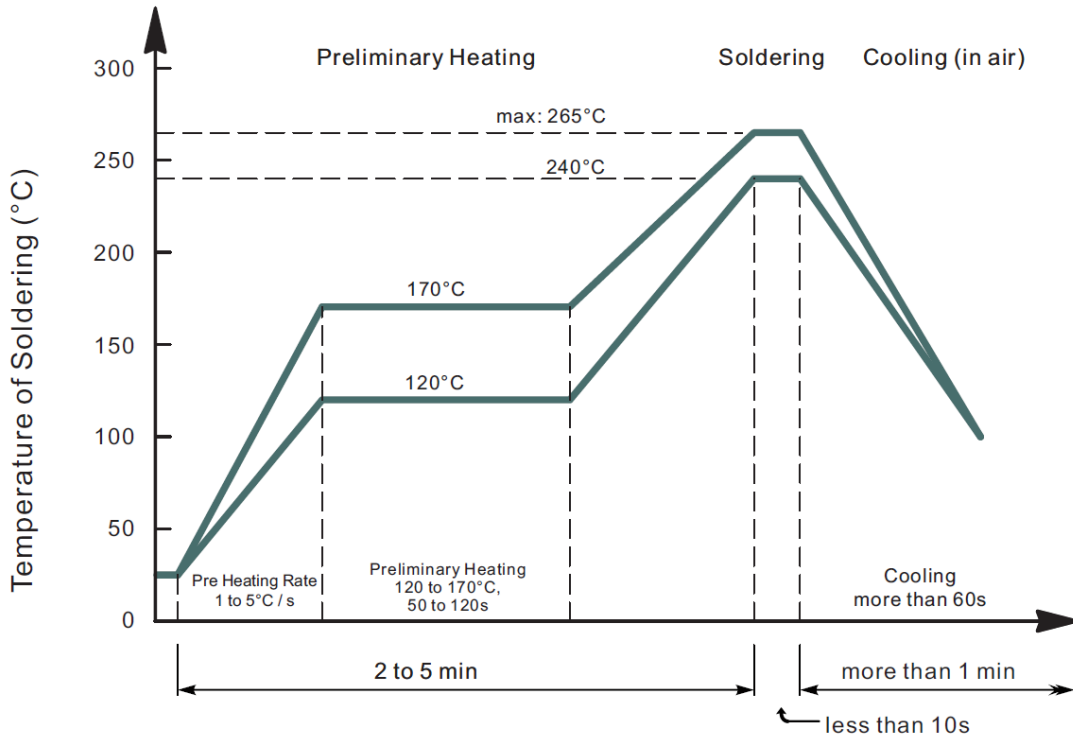

- Recommended peak temperature is over 245°C, If peak temperature is below 245 °C, you may adjust the following parameters; time length of peak temperature (longer), time length of soldering (longer), thickness of solder paste (thicker)
- Welding shall not exceed 2 times
- Remark: lead free solder paste (96.5 sn/3.0 Ag/0.5Cu)

**RATINGS AND CHARACTERISTIC CURVES (For Reference Only)**

Figure 1. Peak Pulse Power Rating Curve

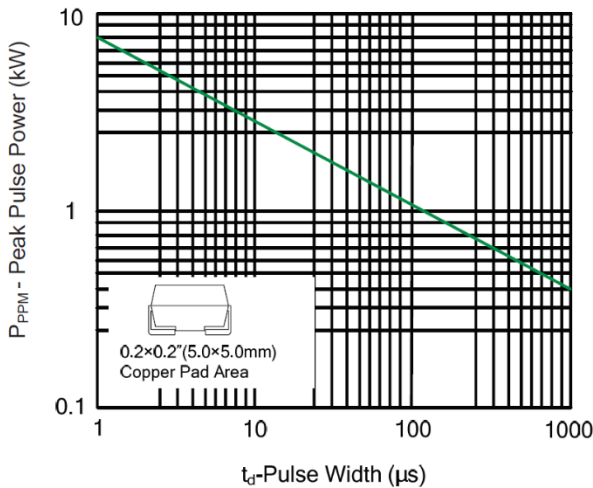

Figure 2. Pulse Derating Curve

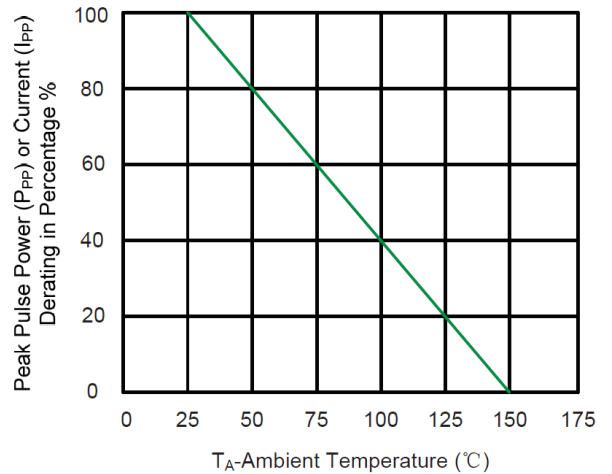

Figure 3. Pulse Waveform

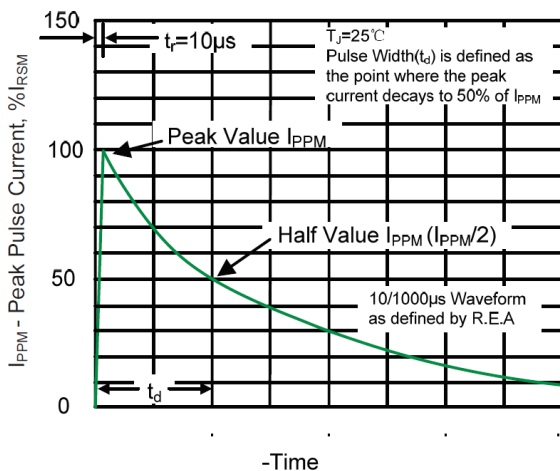

Figure 4. Typical Junction Capacitance

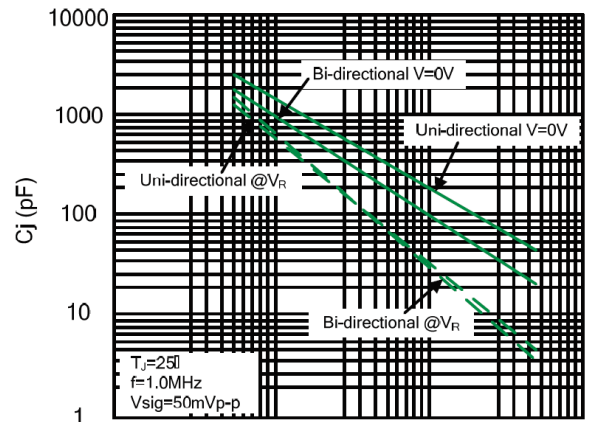
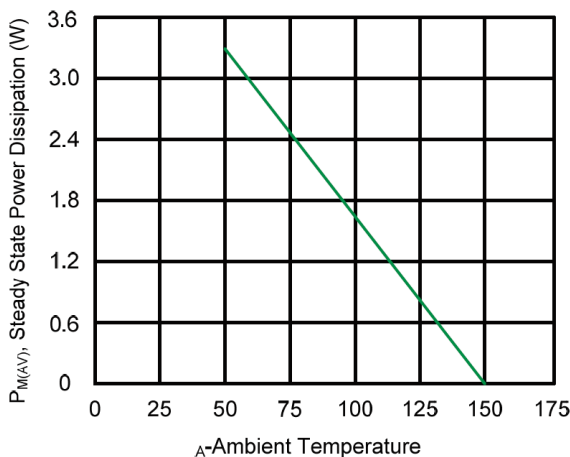
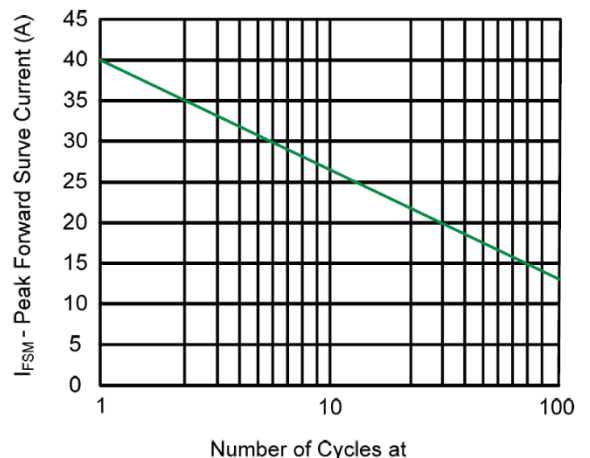

Figure 5. Steady State Power Dissipation Derating curve



-Reverse Breakdown Voltage

Figure 6. Maximum Non-Repetitive Forward Surge Current Uni-Directional Only





**SMD TVs DIODES SOD-123FL SERIES**

**TAPE/REEL (Unit: mm)**

All Devices are packed in accordance with EIA standard RS-481-A and specifications.

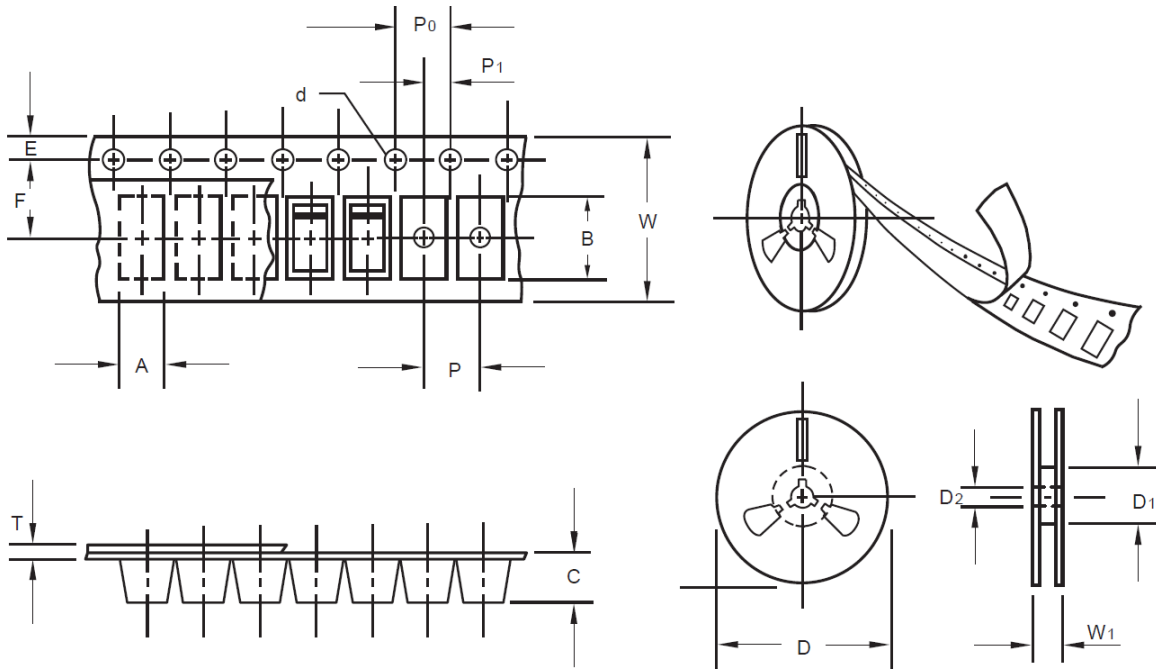

Item	Symbol	Tolerance	SOD-123FL
Carrier width	A	0.1	2.10
Carrier Length	B	0.1	4.00
Carrier Depth	C	0.1	1.60
Sprocket hole	d	0.05	1.55
7"Reel outside diameter	D	2.0	178.00
7"Reel inner diameter	D1	Min.	50.00
Feed hole diameter	D2	0.5	13.00
Sprocket hole position	E	0.1	1.75
Punch hole position	F	0.1	3.50
Punch hole pitch	P	0.1	4.00
Sprocket hole pitch	P0	0.1	4.00
Embossment center	P1	0.1	2.00
Overall tape thickness	T	0.1	0.25
Tape width	W	0.3	8.15
Reel width	W1	1.0	10.50

**SMD TVs DIODES SOD-123FL SERIES**

**PACKAGE**

Case Code	Reel Size	MPQ (pcs)	Component Spacing (mm)	Qty. Per Box (pcs)	Inner Box L*W*H (mm)	Reel Size (mm)	Carton size L*W*H (mm)	Qty. Per Carton (pcs)	G. W (kg)
SOD-123FL	7"	3,000		6,000	210*208*203	178	400*400*250	120,000	9.0

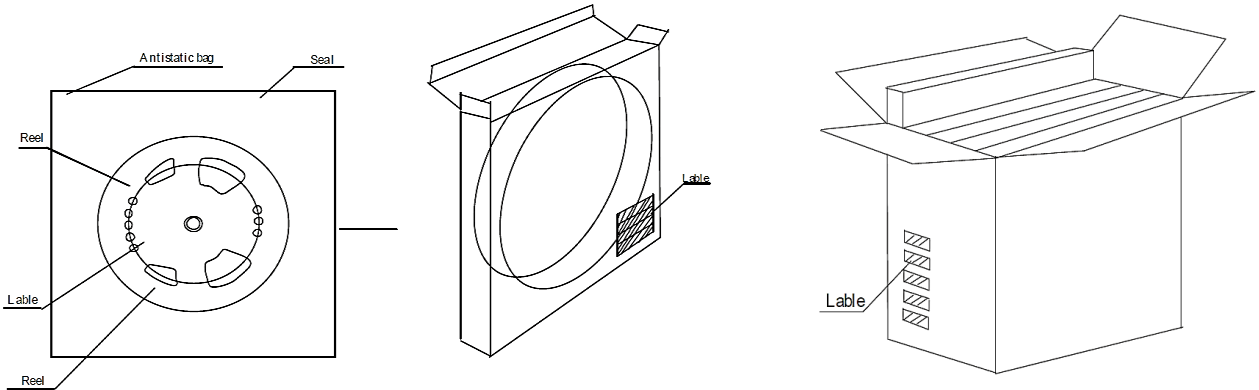

**DISCLAIMER**

NextGen Component, Inc. reserves the right to make changes to the product(s) and or information contained herein without notice. No liability is assumed as a result of their use or application. No rights under any patent accompany the sale of any such product(s) or information