



SPECIFICATION SHEET

SPECIFICATION SHEET NO.	R0408- BSS1230000SSAW	
DATE	Apr. 08, 2024	
REVISION	A0	Updated With Most Recent Data - Official First Release
DESCRIPTION AND MAIN PARAMETRICS	<p>100V N-Channel Enhancement Mode MOSFET, BSS Series, 3 pads BSS123 Type, Case SOT-23 Drain-Source Voltage (V(BR)DSS): 100V Continuous Drain Current (Id): 0.2A Power Dissipation (Pd): 350mW Max. Operating Temp. Range -50°C ~+150°C Package in Tape/Reel, 3000pcs/Reel RoHS III/REACH Compliant and Halogen Free (HF)</p>	
CUSTOMER		
CUSTOMER PART NO.		
CROSS REF. PART NO.		
ORIGINAL MFG/PART NO.	MDD/BSS123	
PART CODE	BSS1230000SSAW	

VENDOR APPROVE
Issued/Checked/Approved <div style="display: flex; justify-content: space-around; margin-top: 10px;">    </div>
DATE: Apr. 08, 2024

CUSTOMER APPROVE
DATE:

100V N-CANNEL ENHANCEMENT MODE MOSFET CASE SOT-23

MAIN FEATURE

- Trench Power MV MOSFET Technology
- Voltage Controlled Small Signal Switch
- Low Input Capacitance
- Fast Switching Speed
- Low Input / Output Leakage
- Surface Mount Package Ideally Suited for Automatic Insertion
- REACH/RoHS III Complaint and Halogen Free
- Cross Main Competitor Parts in Market



APPLICATION

- Small Servo Motor Control
- Power MOSFET Gate Drivers
- Switching Application

PART CODE GUIDE

[RFQ](#)

[Request For Quotation](#)

BSS	123	0000S	SAW
1	2	3	4

1. BSS: SMD N-Channel Enhancement Mode MOSFET, BSS series, 3 pads, Case SOT-23
2. 123: Specification code for BSS123 type.
3. 0000S: Internal Control Code, Custom letter A~Z, a-z or digits (0-9)
4. SAW: Marking code for "SAW" on the case surface

100V N-CANNEL ENHANCEMENT MODE MOSFET CASE SOT-23

DIMENSION (Unit: mm)

Image for reference

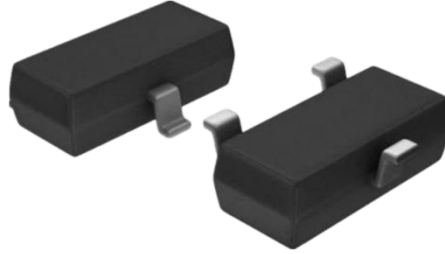

Case SOT-23 Outline

Symbol	Value (mm)		
	Min.	Typ.	Max.
A	0.90		1.40
A1	0.00		0.10
b	0.30		0.50
c	0.08		0.20
D	2.80	2.90	3.10
E	1.20		1.60
E1	2.25		2.80
e	1.80	1.90	2.00
L	0.10		0.50
L1	0.40		0.55
θ	0°		10°

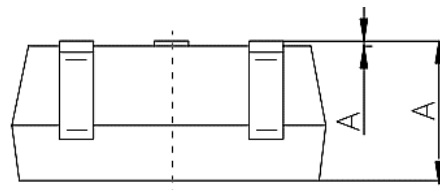
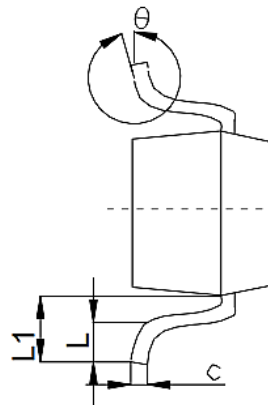
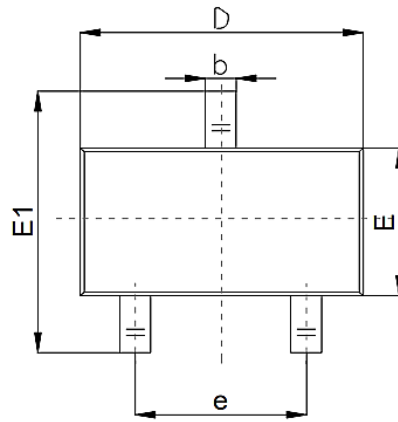

100V N-CANNEL ENHANCEMENT MODE MOSFET CASE SOT-23

EQUIVALENT CIRCUIT

1. Gate (G) 2. Source (S) 3. Drain (D)

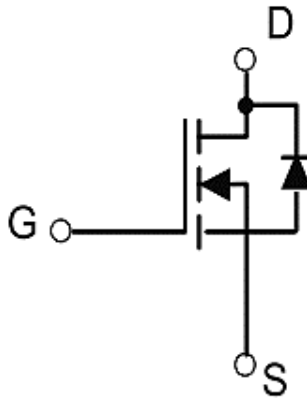
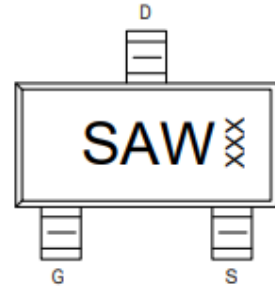
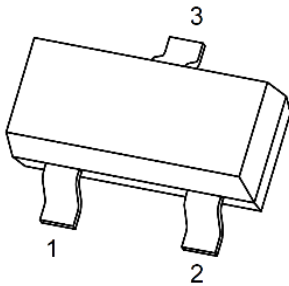

RECOMMEND PAD LAYOUT (For Reference, Unit: Inch/mm, ±0.05mm)

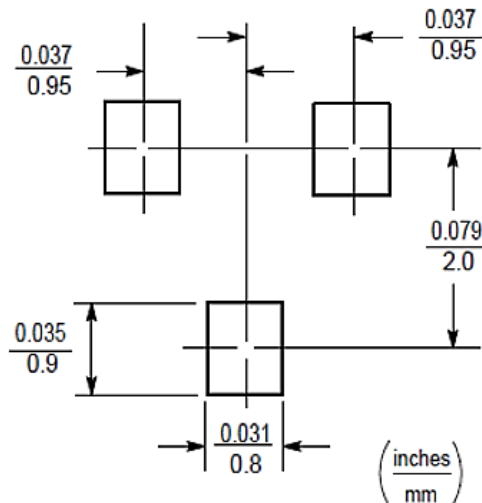

100V N-CHANNEL ENHANCEMENT MODE MOSFET CASE SOT-23
100V N-CHANNEL MODE MOSFET

V(BR)DSS	RDS(on) Max.	ID
100V	5.0Ω@10V	0.20A
	5.5Ω@4.5V	0.20A

MECHANICAL DATA

CASE	TERMINAL	POLARITY	MOUNTING POSITION	WEIGHT PER PIECE
JEDEC SOT-23 molded plastic body	Matte tin plated	Polarity symbol marking on case	Any	0.00019 Ounce, 0.00591 grams

ABSOLUTE MAXIMUM RATINGS (AT Ta=25 °C , unless otherwise specified)

Parameter	SYMBOL	VALUE	UNITS
Drain-Source Voltage	Vds	100	V
Gate-Source Voltage	Vgs	±20	V
Continuous Drain Current	ID	0.20	A
Pulsed Drain Current (See Page 7 Note 1)	IDM	0.8	A
Power Dissipation (See Page 7 Note 2)	PD	350	mW
Thermal Resistance from Junction to Ambient (See Page 7 Note 2)	REJA	357	°C/W
Junction Temperature and Storage Temperature	TJ , TSTG	-50 ~ +150	°C

Notes

Stresses exceeding Maximum Ratings may damage the device. Maximum Ratings are stress ratings only. Functional operation above the Recommended Operating Conditions is not implied. Extended exposure to stresses above the Recommended Operating Conditions may affect device reliability.

100V N-CHANNEL ENHANCEMENT MODE MOSFET CASE SOT-23
MOSFET STATIC CHARACTERISTICS (AT Ta=25 °C unless otherwise specified)

PARAMETER	SYMBOL	VALUE			UNIT	CONDITION
		MIN.	TYP.	MAX.		
Drain-source Breakdown Voltage	V _{(BR)DSS}	100	-	-	V	V _{GS} =0V, I _D = 250μA
Drain-Source Leakage Current	I _{DSS}	-	-	1.0	μA	V _{DS} =100V, V _{GS} =0V
Gate-Source Leakage Current	I _{GSS}	-	-	±100	nA	V _{GS} =±20V, V _{DS} =0V
Gate threshold Voltage	V _{GS(TH)}	1.0	1.8	2.5	V	V _{DS} = V _{GS} , I _D =250μA
Drain-Source On-State Resistance (See Page 7 Note 3)	R _{DS(ON)}	-	3.0	5.0	Ω	V _{GS} =10V, I _D =0.2A
		-	3.5	5.5		V _{GS} =4.5V, I _D =0.175A

DYNAMIC ELECTRICAL CHARACTERISTICS (AT Ta=25 °C unless otherwise specified)

PARAMETER	SYMBOLS	VALUE			UNIT	CONDITION
		MIN.	TYP.	MAX.		
Input Capacitance	C _{iss}	-	32	-	pF	V _{DS} =50V V _{GS} =0V f=1MHz
Output Capacitance	C _{oss}	-	10	-	pF	
Reverse Transfer Capacitance	C _{rss}	-	7	-	pF	
Total Gate Charge	Q _g	-	1.61	-	nC	V _{DS} =50V V _{GS} =10V I _D =0.2A

100V N-CHANNEL ENHANCEMENT MODE MOSFET CASE SOT-23
SWITCHING CHARACTERISTICS (AT Ta=25 °C unless otherwise specified)

PARAMETER	SYMBOLS	VALUE			UNIT	CONDITION
		MIN.	TYP.	MAX.		
Turn on Delay Time	td(on)	-	1.7	-	ns	Vds=50V Vgs= 10V ID= 0.20A RG= 6.0Ω
Turn on Rise Time	tr	-	9	-	ns	
Turn Off Delay Time	td(off)	-	17	-	ns	
Turn Off Fall Time	tf	-	7	-	ns	

SOURCE DRAIN DIODE CHARACTERISTICS (AT Ta=25 °C unless otherwise specified)

PARAMETER	SYMBOLS	VALUE			UNIT	CONDITION
		MIN.	TYP.	MAX.		
Source drain current (Body Diode)	ISD	-	-	0.2	A	Ta=25 °C
Drain-Source Diode Forward Voltage	VSD	-	-	1.2	V	Vgs=0V, Is= 0.2A

Notes

1. Pulse width limited by maximum allowable junction temperature
2. The value of Pd & RθJA is measured with the device mounted on 1 in² FR-4 board with 2oz. Copper, double sided, in a still air environment with Ta=25°C.
3. Pulse test: Pulse width ≤ 300μs, duty cycle ≤2%

100V N-CHANNEL ENHANCEMENT MODE MOSFET CASE SOT-23

TYPICAL PERFORMANCE CHARACTERISTIC CURVES (For Reference Only)

Figure 1. Output Characteristics

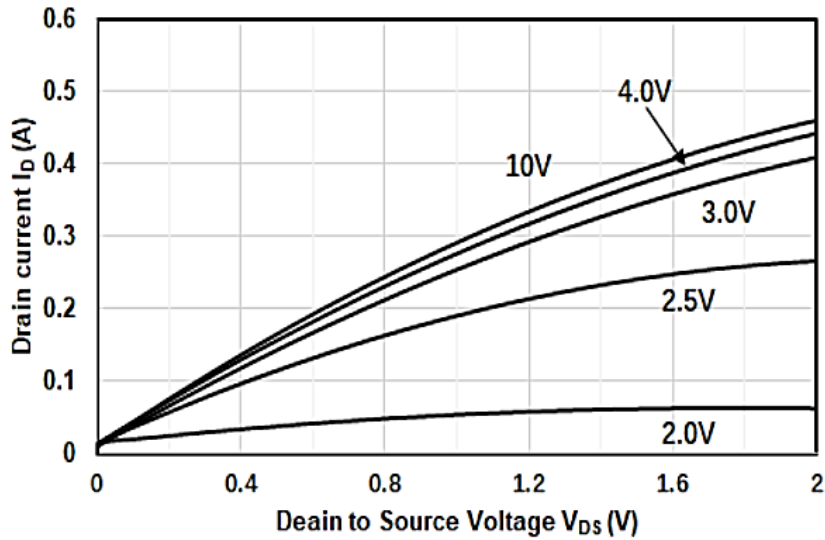
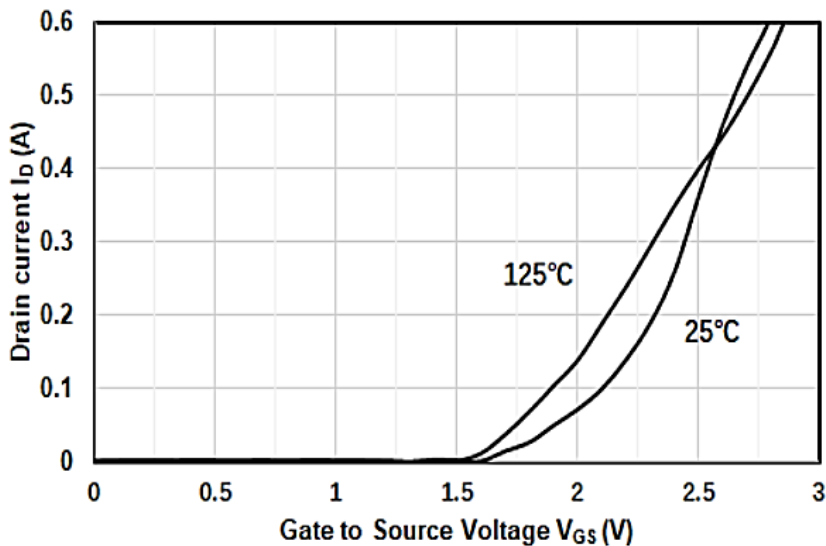

Figure 2. Transfer Characteristics



100V N-CHANNEL ENHANCEMENT MODE MOSFET CASE SOT-23

TYPICAL PERFORMANCE CHARACTERISTIC CURVES (For Reference Only)

Figure 3. Capacitance Characteristics

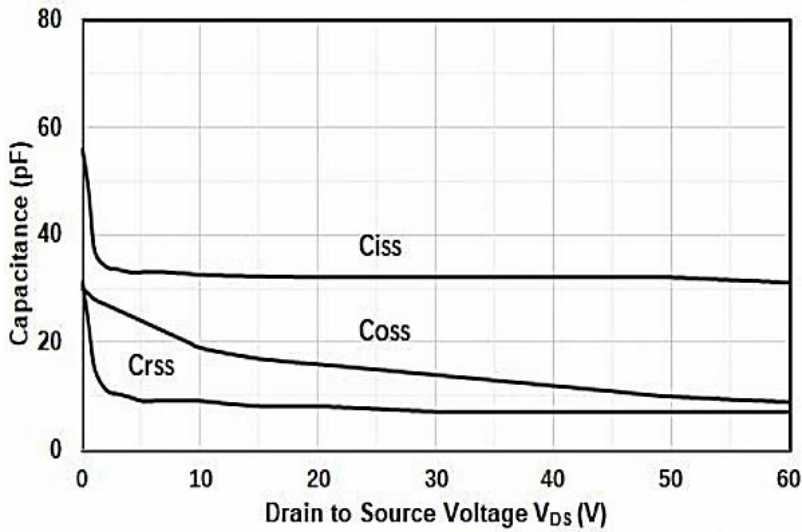
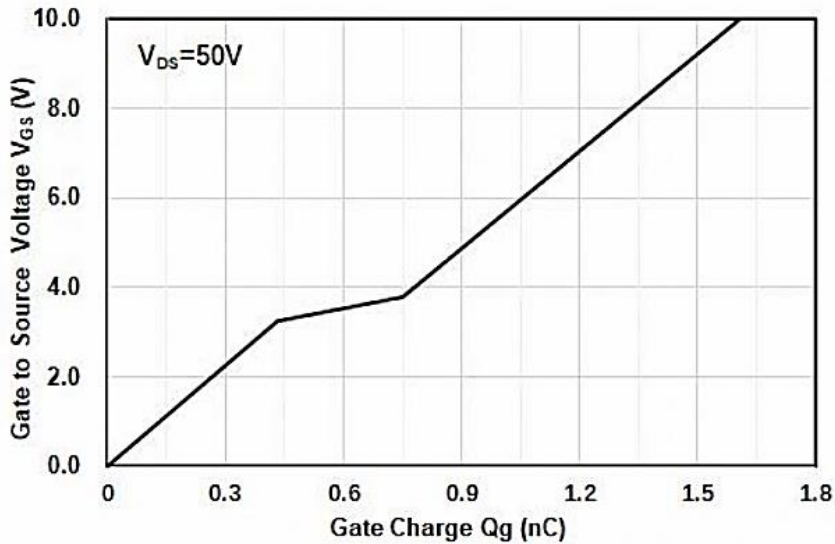

Figure 4. Gate Charge



100V N-CANNEL ENHANCEMENT MODE MOSFET CASE SOT-23

TYPICAL PERFORMANCE CHARACTERISTIC CURVES (For Reference Only)

Figure 5. Drain-Source Current on Resistance

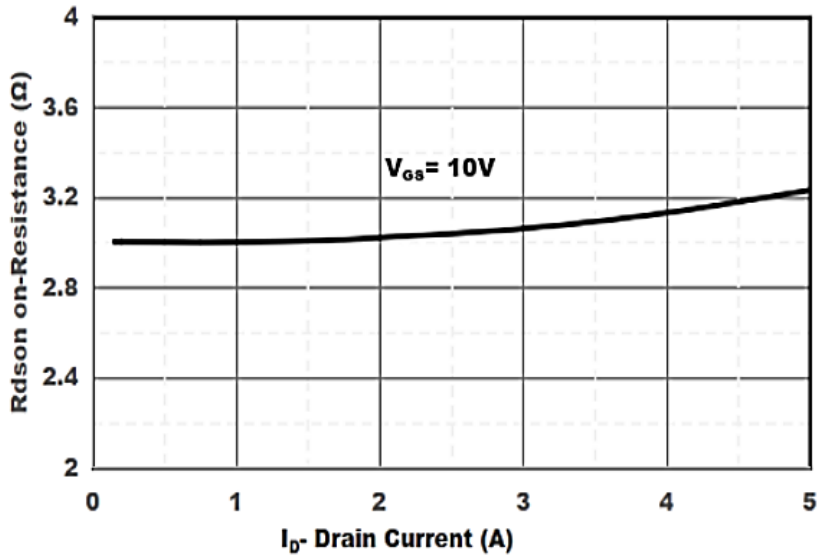
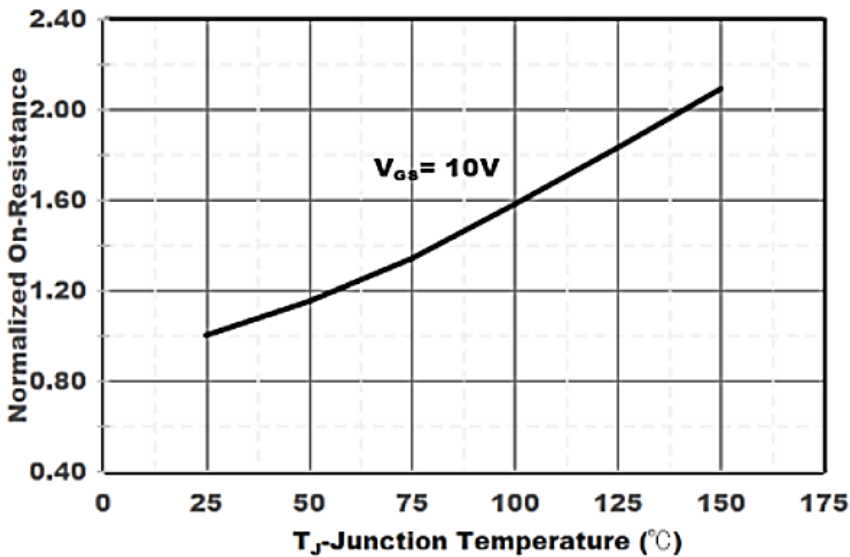

Figure 6. Drain-Source on Resistance



100V N-CANNEL ENHANCEMENT MODE MOSFET CASE SOT-23

TYPICAL PERFORMANCE CHARACTERISTIC CURVES (For Reference Only)

Figure 7. Safe Operation Area

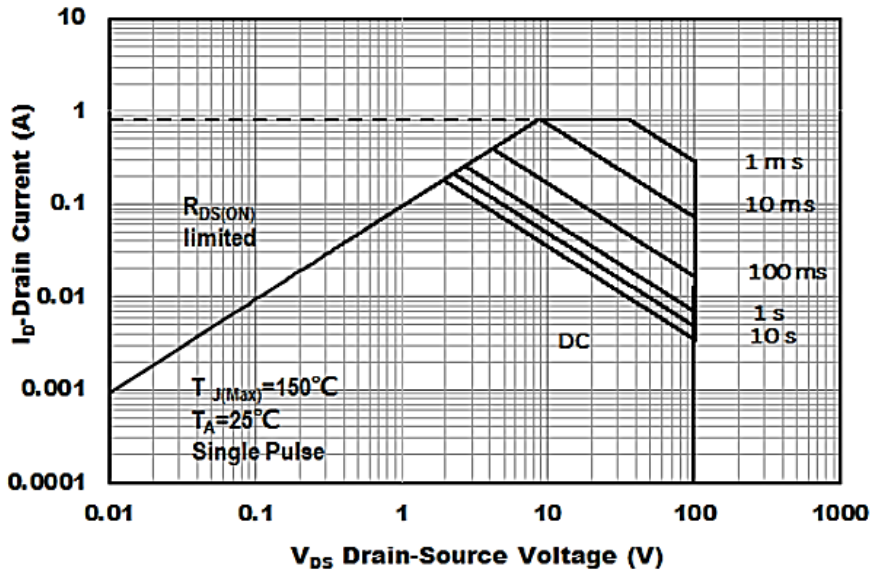
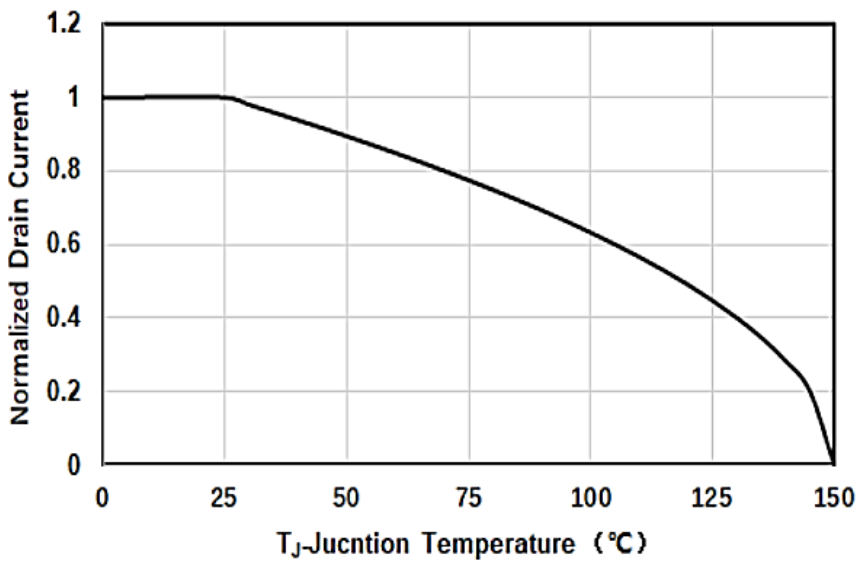

Figure 8. Drain-Source Current



100V N-CHANNEL ENHANCEMENT MODE MOSFET CASE SOT-23

TYPICAL PERFORMANCE CHARACTERISTIC CURVES (For Reference Only)

Figure 9. On-Resistance vs Gate to Source Voltage

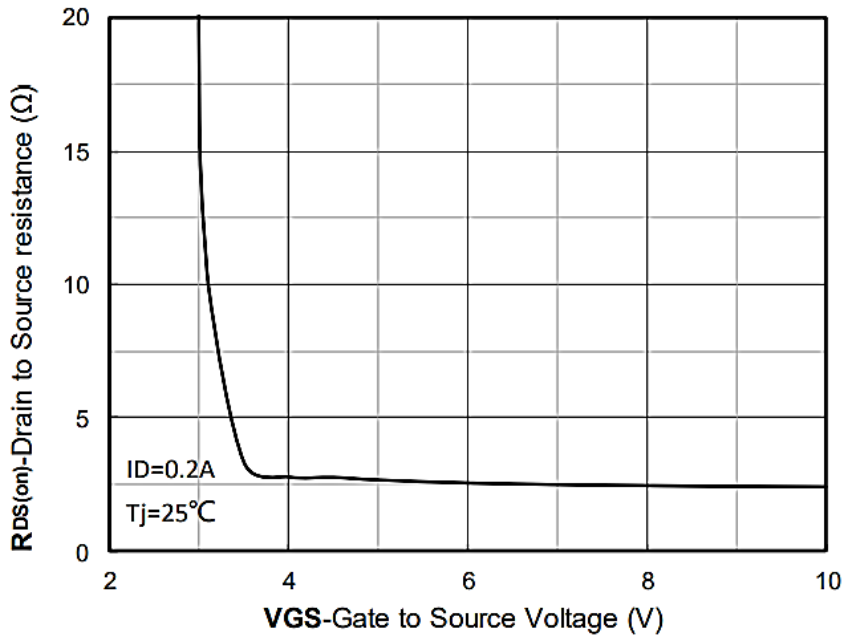
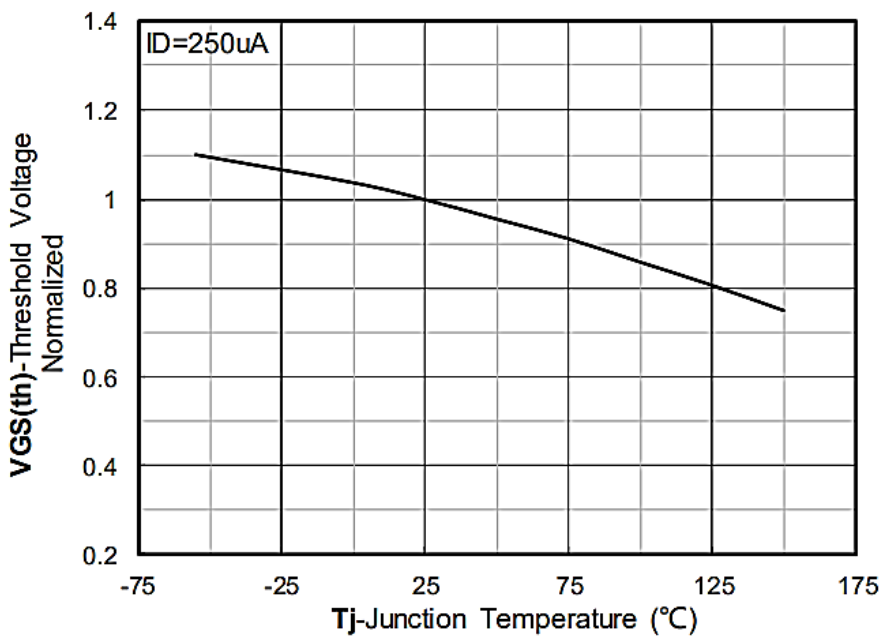

Figure 10. Normalized Threshold voltage



100V N-CHANNEL ENHANCEMENT MODE MOSFET CASE SOT-23
RELIABILITY

NUMBER	EXPERIMENT ITEMS	EXPERIMENT METHOD AND CONDITIONS	REFERENCE DOCUMENTS
1	Solder Resistance Test	Test 260°C± 5°C for 10 ± 2 sec. Immerse body into solder 1/16" ± 1/32"	MIL-STD-750D METHOD-2031.2
2	Solderability Test	230°C ±5°C for 5 sec.	MIL-STD-750D METHOD-2026.1 0
3	Pull Test	1 kg in axial lead direction for 10 sec.	MIL-STD-750D METHOD-2036.4
4	Bend Test	0.5Kg Weight Applied To Each Lead, Bending Arcs 90 °C ± 5 °C For 3 Times	MIL-STD-750D METHOD-2036.4
5	High Temperature Reverse Bias Test	TA=100°C for 1000 Hours at VR=80% Rated VR	MIL-STD-750D METHOD-1038.4
6	Forward Operation Life Test	TA=25°C Rated Average Rectified Current	MIL-STD-750D METHOD-1027.3
7	Intermittent Operation Life Test	On state: 5 min with rated IRMS Power Off state: 5 min with Cool Forced Air. On and off for 1000 cycles.	MIL-STD-750D METHOD-1036.3
8	Pressure Cooker Test	15 PSIG, TA=121°C, 4 hours	MIL-S-19500 APPENOIXC
9	Temperature Cycling Test	-55°C~+125°C; 30 Minutes For Dwelled Time 5 minutes for transferred time. Total: 10 cycles.	MIL-STD-750D METHOD-1051.7
10	Thermal Shock Test	0°C for 5 minutes., 100°C for 5minutes, Total: 10 cycles	MIL-STD-750D METHOD-1056.7
11	Forward Surge Test	8.3ms Single Sale Sine-wave One Surge.	MIL-STD-750D METHOD-4066.4
12	Humidity Test	TA=65°C, RH=98% for 1000 hours.	MIL-STD-750D METHOD-1021.3
13	High Temperature Storage life Test	150°C for 1000 Hours	MIL-STD-750D METHOD-1031.5

100V N-CHANNEL ENHANCEMENT MODE MOSFET CASE SOT-23

SUGGESTED REFLOW PROFILE - For Reference Only

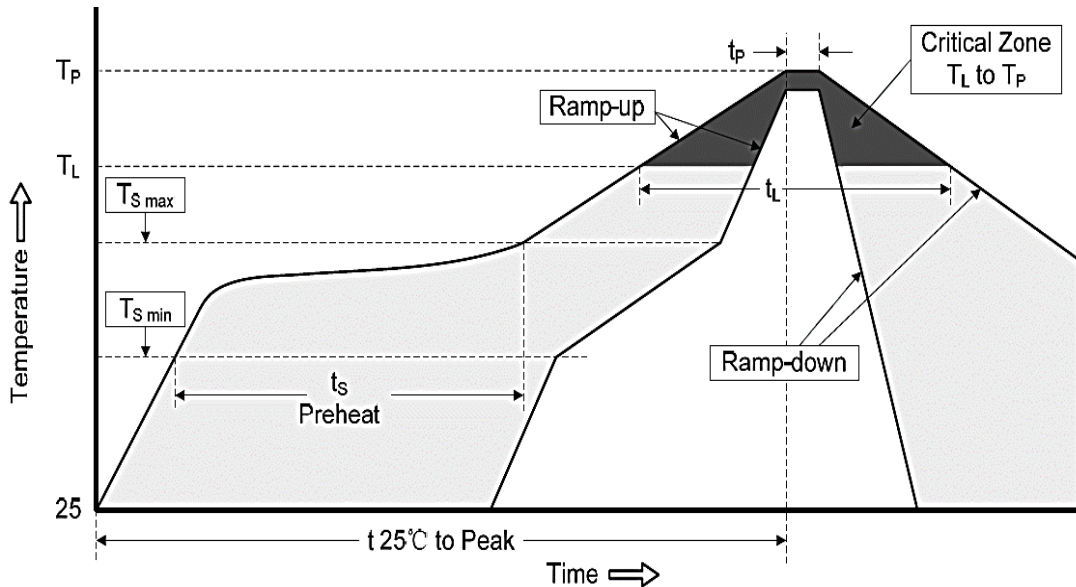

PROFILE FEATURE		PB-FREE ASSEMBLY
Average Ramp-up Rate (Ts Max to Tp)		3°C/second Max
Preheat	Temperature Min (Ts Min.)	150°C
	Temperature Max (Ts Max.)	200°C
	Time (ts Min. to ts Max.)	60 ~ 180 seconds
Time maintained above	Temperature (Tl)	217°C
	Time (tl)	60 ~ 150 seconds
Peak/Classification Temperature (Tp)		260 °C
Time within 5°C of actual Peak Temperature (tp)		20 ~ 40 seconds
Ramp-down rate		6 °C /Second Max.
Time 25 °C to Peak Temperature		8 minutes Max.
Suggest reflow times		3 Times Max.

100V N-CHANNEL ENHANCEMENT MODE MOSFET CASE SOT-23

TAPE/REEL (Unit: mm)

All Devices are packed in accordance with EIA standard RS-481-A and specifications.

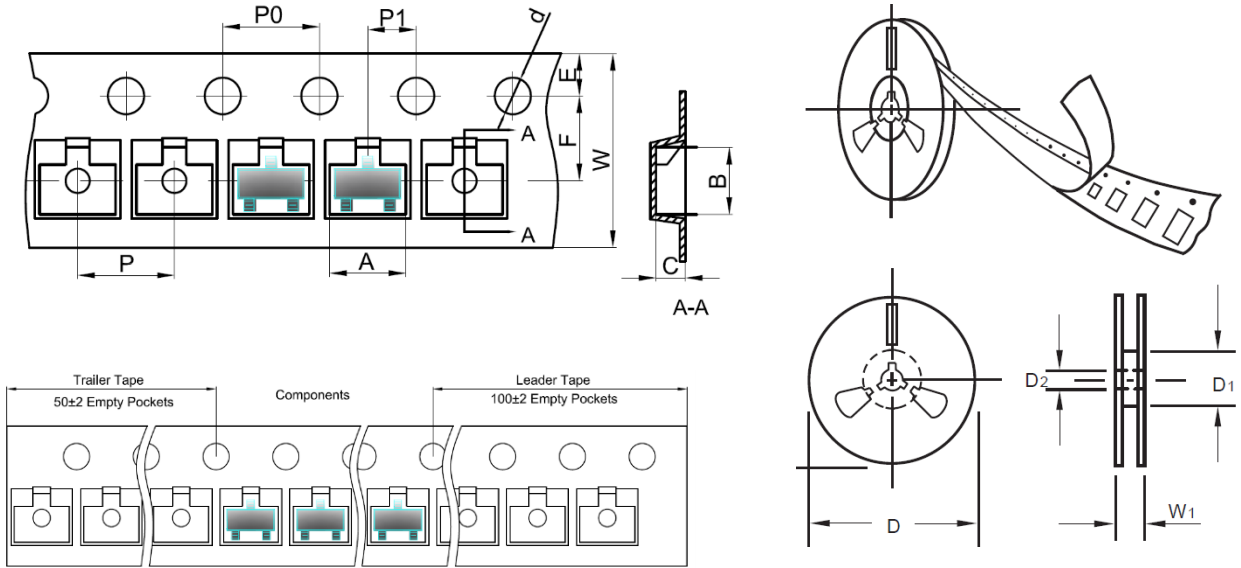

ITEM	SYMBOL	TOLERANCE	SOT-23
Carrier width	A	0.1	3.15
Carrier Length	B	0.1	2.77
Carrier Depth	C	0.1	1.22
Sprocket hole	d	0.05	1.55
7"Reel outside diameter	D	2.0	178.00
7"Reel inner diameter	D1	Min.	54.4
Feed hole diameter	D2	0.5	13.00
Sprocket hole position	E	0.1	1.75
Punch hole position	F	0.1	3.50
Punch hole pitch	P	0.1	4.00
Sprocket hole pitch	P0	0.1	4.00
Embossment center	P1	0.1	2.00
Overall tape thickness	T	0.1	0.25
Tape width	W	0.3	8.00
Reel width	W1	1.0	19.50
Qty. per Reel		3000pcs	

100V N-CANNEL ENHANCEMENT MODE MOSFET CASE SOT-23

ROHS COMPLIANCE

- The levels of RoHS restricted materials in this product are below the maximum concentration values (also referred to as the threshold limits) permitted for such substances, or are used in an exempted application, in accordance with EU RoHS Directive (EU) 2015/863 EC (RoHS3). RoHS Test Report for this product can be obtained can be obtained at Download Center.

REACH COMPLIANCE

- REACH substances of high concern (SVHCs) information is available for this product. Since the European Chemical Agency (ECHA) has published notice of their intent to frequently revise the SVHC listing for the foreseeable future, REACH Test Report for this product can be obtained can be obtained at Download Center.

IMPORTANT NOTES AND DISCLAIMER

1. All Product parametric performance is indicated in the Electrical Characteristics for the listed herein test conditions, unless otherwise noted. Product performance may not be indicated by the Electrical Characteristics if operated under different conditions.
2. NextGen Component, Inc (*NextGen*) reserves the right to make changes to this document and its products and specifications at any time without notice. Customers should obtain and confirm the latest product information and specifications before final design, purchase or use.
3. *NextGen* makes no warranty, representation or guarantee regarding the suitability of its products for any particular purpose, not does NextGen assume any liability for application assistance or customer product design.
4. *NextGen* does not warrant or accept any liability with products which are purchased or used for any unintended or unauthorized application. No license is granted by implication or otherwise under any intellectual property rights of NextGen.
5. *NextGen* products are not authorized for use as critical components in life support devices or systems without express written approval by *NextGen*.
6. *NextGen* requires that customers first obtain an RMA (Returned Merchandise Authorization) number prior to returning any products. Returns must be made within 30 days of the date of invoice, be in the original packaging, unused and like-new condition. At the time of quoting or purchasing, a product may say that it is Non-Cancelable/ Non-Returnable (NCNR). These products are not returnable and not refundable.